

Miller

USE YOUR SENSES

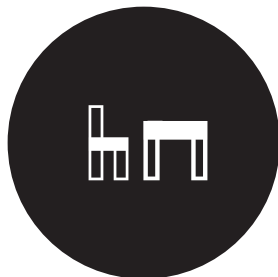

USE YOUR SENSES

HERAUSGEBER

editor

Hiller Objektmöbel GmbH
Kippenheimer Straße 6
77971 Kippenheim

t +49 (0) 7825.901 0
e contact@hiller-moebel.de
www.hiller-moebel.de

KREATION | PRODUKTION

creation & production

atelier schneeweiss GmbH
Zu Schloss Schmieheim
Im Schlossgarten 1
77971 Schmieheim

t +49 (0) 7825.877 17 0
e info@atelier-schneeweiss.com
www.atelier-schneeweiss.de

BILDNACHWEISE

photo credits

S. 36 | © MAK/Georg Mayer
S. 132 | © Elfie Semotan
S. 134-139 | Portraits | Scribbles | Renderings
© Delugan Meissl Industrial Design
S. 146 | © IMAGNO/Franz Hubmann
S. 150 | © Matthias Hermann
S. 169 | © Michael Morten Neumayr

DRUCK

printing

Straub Druck + Medien AG
Max-Planck-Straße 17-19
78713 Schramberg

FOTOGRAFIE

photography

Fotostudio Lutwin Johannes
Golfstraße 35
60528 Frankfurt

© 2016 Hiller Objektmöbel GmbH

Alle Rechte vorbehalten. Diese Publikation ist urheberrechtlich geschützt. Jede Verwertung, insbesondere der Nachdruck, die Vervielfältigung, Einspeicherung und Verarbeitung, auch auszugsweise, bedürfen der vorherigen schriftlichen Genehmigung durch die Hiller Objektmöbel GmbH. Die Hiller Objektmöbel GmbH ist bestrebt, die Rechte Dritter zu respektieren. Sollten diese im Einzelfall nicht erwähnt worden sein, so handelt es sich um ein Versehen, das entsprechend korrigiert wird. Aus drucktechnischen Gründen sind Farbabweichungen möglich.

Alle Preisangaben zzgl. MwSt. | Irrtümer und Änderungen vorbehalten | Es gelten unsere Allgemeinen Geschäftsbedingungen: www.hiller-moebel.de/agb/

All rights reserved. This catalog is protected by copyright. Any use of parts of this catalog or the entire publication, particularly in print or electronic form, in infringement of copyright law is prohibited without the written permission of Hiller Objektmöbel GmbH. This applies in particular to reproduction, distribution, processing, publication or other copyrighted use, including the right of making available.

Hiller Objektmöbel GmbH makes every effort to respect the laws and the rights of third parties. If such rights have not been mentioned in a particular case, this is an editorial mistake that will be corrected accordingly. The colors and finishes shown are subject to the limitations of the printing process and cannot be regarded as binding. **All prices stated are subject to VAT at the statutory rate | All data with reservation and subject to change | Our General Terms and Conditions of Business apply: www.hiller-moebel.com/agb/**

Miller

2

IMPRESSUM

imprint

8 - 13

FIRMENPORTRAIT

company portrait

14 - 15

**AUSGEWÄHLTE
REFERENZEN**

selected references

16 - 173

SITZMÖBEL

seating furniture

174 - 261

TISCHE

tables

18 - 25

ELESS

Kufenstuhl | Barhocker
skid-base chair | barstool

26 - 29

KARLSSON

Kufenstuhl
skid-base chair

30 - 35

ATICON

Vierfußstuhl | Barhocker
four-legged chair | barstool

36 - 41

GARCIA

Vierfußstuhl | Barhocker
four-legged chair | barstool

42 - 47

ARKETTO

Vierfußstuhl
four-legged chair

48 - 59

LOGOCHAIR

Vierfußstuhl | Freischwinger |
Barhocker | Bank
four-legged chair | cantilever
chair | barstool | bench

60 - 63

ATLANTA 456

Vierfußstuhl
four-legged chair

64 - 69

ATLANTA 450

Vierfußstuhl
four-legged chair

70 - 75

ATLANTA 55 | 66 | 67

Vierfußstuhl | Freischwinger
four-legged chair | cantilever chairs

76 - 79

LISTO

Vierfußstuhl
four-legged chair

INHALTSVERZEICHNIS

80 - 91

BONNIE & CLYDE

Vierfußstuhl | Barhocker |
Bank | Tisch
four-legged chair | barstool |
bench | table

112 - 123

RONDO

Vierfußstuhl | Hochlehner |
Sessel | Bank | Polstermöbel
four-legged chair | high-back
chair | armchair | bench |
upholstered furniture

140 - 147

KOLLEKTION.58 KARL SCHWANZER

Vierfußstuhl | Tisch | Fauteuil |
Side Table
four-legged chair | table | fauteuil |
side table

156 - 161

ULTIMO

Polstermöbel | Beistelltisch
upholstered furniture | side table

92 - 105

PAN

Vierfußstuhl | Hochlehner | Fau-
teuil | Barhocker | Bank | Tisch
four-legged chair | high-back
chair | armchair | barstool |
bench | table

124 - 133

LI-LITH

Vierfußstuhl | Barhocker | Bank
four-legged chair | barstool |
bench

148 - 151

KRISCHANITZ KOLLEKTION BENTWOOD

Vierfußstuhl | Sessel | Liegen
four-legged chair | armchair |
daybed | chairbed

162 - 169

STRESEMANN

Loungemöbel | Barhocker
loungue furniture | side table

106 - 111

ELENA

Vierfußstuhl | Barhocker
four-legged chair | barstool

134 - 139

TENDO

Vierfußstuhl
four-legged chair

152 - 155

CORE

Bank
bench

170 - 173

WIENER FAUTEUIL

Fauteuil | Barhocker |
Beistelltisch
armchair | barstool | side table

176 - 181

DELTA 110

Klapptisch
folding table

182 - 193

DELTA 100

Klapptische
folding tables

194 - 209

SYSTEM 24

Klapptische
folding tables

210 - 215

206 . 207

Tische
tables

216 - 221

LOGOTABLE

Tische
tables

222 - 233

TABULA LIGHT

Tische
tables

234 - 241

410 . 411 . 412

Tische | Stehtisch
tables | stand-up table

242 - 245

STAND UP

Klappbarer Stehtisch
folding stand-up table

246 - 251

2960 . 2961 . 2970 . 2970

Stehtische | Bistrotische
stand-up tables | bistro tables

252 - 261

LIMES

Bänke | Tische
benches | tables

INHALTSVERZEICHNIS

262 - 272

ZUBEHÖR

accessories

273

KANTENPROFILE

edge profiles

274 - 297

HANDWERK

craftsmanship







298 - 303

INDEX

Produktübersicht
product overview

LEGENDE

legend

	GESTELLFARBEN frame colors	285		STOFFE fabrics	295
	LACKE BEIZEN stains & varnishes	291		OBERFLÄCHEN surfaces	281
	ZUBEHÖR accessories	262		HOLZ wood	279

IDEENSCHMIEDE VEREINT MIT HOHER FERTIGUNGSTIEFE

CREATIVE LAB MEETS HIGH VERTICAL INTEGRATION



ALLES AUS EINER HAND: ANGEFANGEN VON DER IDEE ÜBER ANALYSE, KONZEPTION UND DESIGN BIS HIN ZU FERTIGUNG, MONTAGE UND EINLAGERUNG. WIR UNTERSTÜTZEN SIE VON BEGINN AN UND BEGLEITEN SIE BIS ZUM SCHLUSS, BIETEN PASSENDE MARKETINGKONZEPTIONEN ZU IHREM PROJEKT SOWIE DAS KNOW-HOW IN SÄMTLICHEN BEREICHEN. DASS DIES KEIN LEERES VERSPRECHEN IST, ZEIGT UNSERE AUSSERGEWÖHNLICHE FERTIGUNGSTIEFE VON 76 PROZENT. SIE HABEN DAMIT EINEN KOMPETENTEN PARTNER AN DER SEITE, DER DIE UMSETZUNG IHRER SPEZIFISCHEN ANFORDERUNGEN IN DIE HAND NIMMT. UND ZWAR VON A BIS Z, DAMIT SIE SICHERGEHEN KÖNNEN, DASS NICHT NUR OBERFLÄCHLICH ALLES STIMMT. AUCH LEASING UND VERLEIH IST STETS EINE OPTION. ZÖGERN SIE BITTE NICHT UNS ZU KONTAKTIEREN. WIR BERATEN SIE ZU ALLEN THEMEN GERNE UND JEDERZEIT.

Everything from a single source: starting from an idea to analysis, conception and design up to construction, logistics and assembly. We support our customers throughout the whole process and offer customized solutions in the area of marketing as well as our long-standing expertise in all areas. Our extraordinary vertical integration of 76 per cent shows, that this is no empty promise. You can rely on an expert partner, who is responsible for every aspect of your project. Leasing and rental are also options at all times. If you would like to receive further information on all subjects or simply wish to contact us, please do not hesitate to do so.

1936

1949

1960

FERTIGUNG

von abwaschbaren Brauereitischen und passenden Bauernstühlen aus Buchenholz und Kunstharzlack.

PRODUCTION

of washable restaurant tables and matching rustic chairs made of beech wood and synthetic resin varnish.

GRUNDSTEIN

Stapeln, Klappen, Falten

Den Grundstein für die Produktion von Stahlrohrstühlen legt die hauseigene Schlosserei. Erich Hiller entwickelt den ersten Klappstisch und macht die Stapelfähigkeit von Holzstühlen salonfähig.

DER BEGINN

Erich und Herbert Hiller gründen im badischen Kippenheim einen handwerklichen Betrieb zur Herstellung von Holzdrehwaren und Wollbesen für den Haushalt.

THE START

Erich and Herbert Hiller found a craft enterprise that focuses on the manufacturing of wooden products as well as wooden broomsticks for the household.

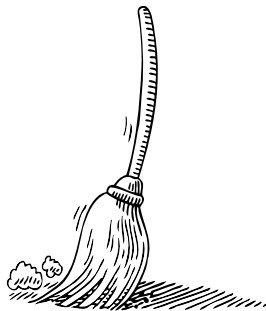

FOUNDATION

stack, clap, fold

The foundation for the production of tubular steel chairs is laid by the company's own locksmith department. Erich Hiller develops the first folding table and makes the stacking of wooden chairs publicly respectable.

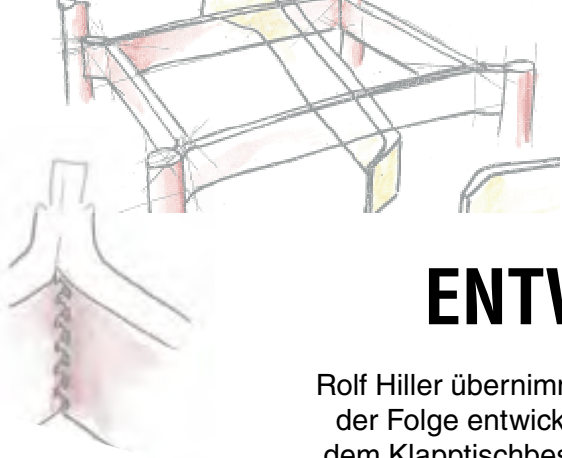

ENTWICKLUNG

Rolf Hiller übernimmt die elterliche Firma. In der Folge entwickelt das Unternehmen mit dem Klappptischbeschlag „DeltaStat“, der bis heute als „Tisch 105“ im Einsatz ist, und dem verwindungsfähigen Schichtholzrahmen „GenioFlex“, der Bodenunebenheiten ausgleicht und Kräfteeinwirkungen auf das Gestell reduziert, zwei wesentliche technische Alleinstellungsmerkmale.

GROWTH

Rolf Hiller takes over the family business. Subsequently, the company develops two unique technological features: “DeltaStat”, a patented hinge which is still used within the delta table collection and “GenioFlex”, a flexible laminated wood frame that automatically compensates for uneven floors.

ÜBERNAHME

Hiller übernimmt den auf das Gründungsjahr 1921 zurückgehenden österreichischen Objektmöbelhersteller BRAUN Lockenhaus.

TAKE-OVER

Hiller takes over the Austrian contract furniture manufacturer BRAUN Lockenhaus, founded in 1921.

1975

1996

2004

2005

FOKUS

Mit einem zertifizierten Qualitätsmanagementsystem gemäß dem internationalen Standard ISO 9001 beweist Hiller bereits 1996, dass Qualitätsorientierung in jedem Teilprozess das unternehmenseigene Denken und Handeln bestimmt. 2011 folgt die Zertifizierung gemäß der internationalen Umweltmanagementnorm ISO 14001.

FOCUS

With a certified quality management system in accordance with the international standard ISO 9001, Hiller proves already in 1996, that a strong focus on quality implemented for each individual process determines the company-own thoughts and actions.

UMSATZREKORD

Die Umsatzzahlen erreichen zum ersten Mal in der Unternehmensgeschichte die beeindruckende Marke von über 15.000.000 Euro.

SALES RECORD

For the first time the company's sales figures reach the impressive benchmark of more than 15.000.000 euro.

WILLKOMMEN IM EINFALLSREICH

Das neu ins Leben gerufene atelier schneeweiss ist als inhouse Werbeagentur die Ideenwerkstatt der SCHNEEWEISS AG Interior. Mit Sitz im Schloss zu Schmieheim entstehen einzigartige Konzepte und Designs für umfassende Marketingstrategien.

WELCOME TO A WORLD OF INGENUITY

atelier schneeweiss is brought to life in 2009 and serves as an in-house advertising agency and creative lab for SCHNEEWEISS AG Interior. Situated at Schmieheim castle unique marketing concepts and solutions are created.

NEUE BASIS

Aus der Hiller-Gruppe wird die SCHNEEWEISS AG Interior. Die Gründung der Aktiengesellschaft eröffnet zukunftsgerichtete Perspektiven und zielt auf eine klare, gleichberechtigte Positionierung der Einzelmarken sowie auf die Stärkung der Unternehmensstandorte.

A NEW BASIS

The Hiller Group becomes SCHNEEWEISS AG Interior. The foundation of the corporation opens future-oriented perspectives and aims at a clear and equal positioning of the individual brands as well as at the strengthening of the company sites.

20
08

VEREINIGUNG

Die Hiller-Gruppe übernimmt die seit 1873 bestehende Edelstahlmanufaktur rosconi.

UNIFICATION

The Hiller Group takes over the stainless steel manufacturer rosconi.

20
09

20
10

LOGISCH!

Die SCHNEEWEISS AG Interior gründet ihr eigenes Logistikunternehmen, um bei der Projektabwicklung auch im letzten Schritt die Kunden mit maßgeschneiderter, fachmännischer Expertise zu unterstützen.

LOGICALLY!

SCHNEEWEISS AG Interior establishes a company-own logistic enterprise in order to provide professional expertise for the customer even within the last step of a project.

25 DESIGNPREISE

Die Designerstühle tendo (entworfen von Delugan Meissl Industrial Design, den kreativen Köpfen hinter dem Porsche Museum Stuttgart) und li-lith (Gregor Eichinger) war den mit renommierten Designpreisen wie dem i F product design award oder dem Good Design Award ausgezeichnet. Insgesamt erhält das Produktportfolio über die Jahre hinweg 25 Designpreise.

25 DESIGN AWARDS

The designer chairs tendo (designed by Delugan Meissl Industrial Design, the creative minds behind the Porsche Museum, Stuttgart) and li-lith (Gregor Eichinger) are awarded with renowned design awards such as the iF product design award or the Good Design Award. Over the years the product portfolio receives more than 25 design awards.



20
15

HEUTE
TODAY

BREIT AUFGESTELLT

Die Dienstleistungen der SCHNEEWEISS AG Interior sind umfangreich. Großprojekte mit hohen Stückzahlen, das Exportgeschäft und der Bereich „Individueller Innenausbau“ bilden die aktuellen Schwerpunkte der Unternehmensgruppe. Dank der hohen Fertigungstiefe von rund 76 Prozent ist es möglich, auf kundenspezifische Wünsche einzugehen, für jede Raumsituation eine optimale Planung zu erstellen sowie bezahlbar zu verwirklichen. Die Unternehmensgruppe beschäftigt heute rund 250 Mitarbeiter in Deutschland und Österreich, fertigt 400.000 Objektmöbel pro Jahr und erwirtschaftet einen Jahresumsatz von über 50.000.000 EUR.

BROAD SPECTRUM

The services of SCHNEEWEISS AG Interior are comprehensive. Large-scale projects with high numbers of units, the export business and the segment “professional interior design” build the current focus of the company group. Thanks to the high vertical integration of around 76 percent, it is possible to respond to customer-specific requirements, to create an optimal planning for every room situation and to run the project at an affordable price. Around 250 employees in Germany and Austria manufacture more than 400,000 items of contract furniture per year. The company group has an annual turnover of over 50,000,000 euro.

Nichts ist aussagekräftiger als zufriedene Kunden. Im Lauf der Jahre konnten wir zahlreiche namhafte Kunden mit unseren Designklassikern und Produktinnovationen überzeugen.

Nothing is more meaningful than satisfied customers. Over the years we could convince numerous renowned customers with our design classics and product innovations.

SELECTED REFERENCES

SCHNEEWEISS AG

BERLIN

Barmer GEK

21er Haus, Wien | Österreich

Austria Center Vienna, Wien | Österreich

Café Motto am Fluss, Wien | Österreich

HAMBURG

Elbphilharmonie

DB Schenker, Essen

Dessau Center, Dessau

Deutsche Messe AG, Hannover

MÜNCHEN

BMW Group Werk 1

École Européenne, Mamer | Luxembourg

Europahalle / Kongresszentrum | Karlsruhe

Festspielhaus, Erl | Österreich

WIEN

Lugeck

Flughafen BER, Berlin

Fraport AG, Frankfurt am Main

Holsten-Galerie, Neumünster

LAHR

Zalando

King Abdulaziz International Airport, Jeddah | Saudi-Arabien

Landeskrankenhaus Neunkirchen | Österreich

MARSTALL, Ludwigsburg

Messe Leipzig GmbH, Leipzig

pro mente Haus, Mattersburg | Österreich

Rehabilitationszentrum Bad Tatzmannsdorf | Österreich

Samsung Hall, Zürich | Schweiz

Skyline Plaza, Frankfurt am Main

Stadion Mainz 05

Stadthalle Reutlingen

Weserpark, Bremen

Wirtschaftsuniversität Wien | Österreich

World Conference Center, Bonn



SITZMOEBEL

SEATING FURNITURE

ELESS



-
- 1 Weiß decklackierte Schale | Gestell aus Rundstahl, weiß polyamidbeschichtet · white varnished shell | frame made of round steel, polyamide-coated in white
 - 2 Schwarz gebeizte Schale mit Vorpolyester | Gestell aus Rundstahl, verchromt · shell with black varnish and fully upholstered front | frame made of round steel, chrome-plated
 - 3 Schale mit schwarzem Schichtstoff belegt | Gestell aus Rundstahl, verchromt · shell with black laminate cover | frame made of round steel, chrome-plated



3



ELESS

Der elegante Kufenstuhl Eless ist auf das Wesentliche reduziert. Die Kombination aus einem sehr schlanken Gestell und einer geradlinigen Schale ermöglicht Stapel von bis zu 45 Stühlen. Aufgrund der schlichten, reduzierten Form und der zahlreichen Farbvarianten passt sich Eless perfekt an verschiedene Raumkonzepte an.

The elegantly designed Eless skid-base chair has been reduced to its core essentials. The combination of an extremely slim frame with a linear shell enables up to 45 chairs to be stacked together. Due to its pure, minimalist design and numerous color choices Eless suits various architectural concepts perfectly.

ELESS



1



2



3

-
- 1 Ungepolstert · without upholstery
 - 2 Sitzpolster · seat upholstered
 - 3 Sitz- und Rückenpolster · seat and backrest upholstered
 - 4 Durchgehendes Vorpilster · fully upholstered front
 - 5 Vollpolster · fully upholstered

AUSFÜHRUNG . DESIGN

Die Sitzmöbel sind in vielen verschiedenen Farben, Materialien und Veredelungen erhältlich. Für die Polsterung stehen zahlreiche Stoffe, Leder und Kunstleder zur Verfügung.

The seating furniture is available in various colors, materials and finishings. Several fabrics, leathers and artificial leathers can be chosen for upholstery.

ELESS



813 | 860 493 520 450 | 460 6,3-8,0 7-45

Gestell

Rundstahl
verchromt | polyamidbeschichtet
gemäß Hauskollektion

Schale

Formholz
Lack | Beize | Holzfurnier | Schichtstoff
gemäß Hauskollektion

Optionen

Reihenverbindung über
Kunststoff- oder Filzgleiter

Zertifizierung

GS – Geprüfte Sicherheit

Preis

ab EUR 149,-



4



5

frame

round steel
chrome-plated | polyamide-coated
according to house collection

shell

plywood
varnish | stain | wood veneer | laminate
according to house collection

design options

row connection via polyamide or felt gliders

certification

GS – tested safety

price

from EUR 149,-

SCHALEN . SHELLS

420 | H 813 mm



421 | H 860 mm



Schalenkonturen
frei wählbar
free choice of
shell contours



262



285



279



291



295



281

ELESS

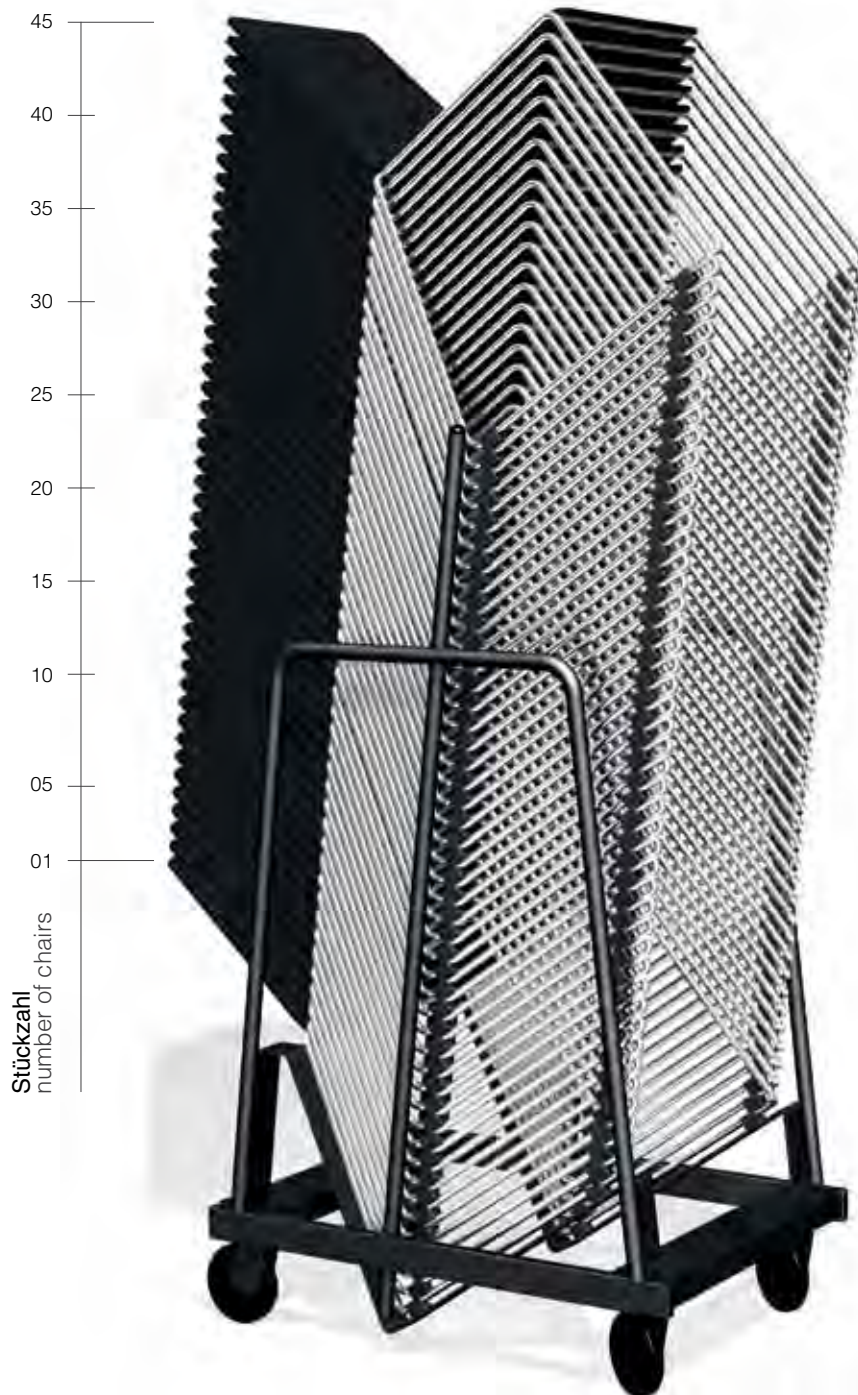

STAPELUNG . STACKING

Stapelabstand: 20-36 mm
stacking distance: 20-36 mm

Gesamt-Stapelhöhe
7 Stühle: 970 mm | 45 Stühle: 1950 mm
total stacking height
7 chairs: 970 mm | 45 chairs: 1950 mm



1



2



3

-
- 1 Armlehne | armrest
 - 2 Komfortschlitz | comfort slot
 - 3 Schreibrtablet | writing tablet

ARMLEHNEN . ARMRESTS



Stahl
steel



Softgripschlauch
soft grip tube

REIHENVERBINDUNG . GANGING DEVICE



2 in 1: Gleiter und Reihen-
verbindung in einem
2 in 1: glider and ganging
device

ELESS



1



2

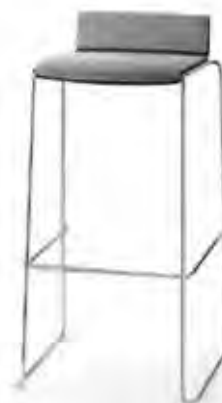

3

-
- 1 **Ungepolstert** · not upholstered
 - 2 **Sitzpolster** · seat upholstered
 - 3 **Sitz- und Rückenpolster** · seat and backrest upholstered
 - 4 **Durchgehendes Vorpilster** · fully upholstered front
 - 5 **Vollpolster** · fully upholstered

BARHOCKER . BARSTOOL

Dank des filigranen Gestells aus Vollstahl hat der Kufen-Barhocker Eless eine besonders elegante Optik und ist damit ideal für Tresen und Theken. Das Beste: Er ist stapelbar und nimmt nicht viel Platz bei der Lagerung ein. Verschiedene Farben, Dekore und Polstervarianten ermöglichen eine individuelle Anpassung an Raum- und Farbkonzepte.

Due to its filigree steel frame the skid-base barstool Eless adds an exceptionally elegant and attractive appearance to every bar area. On top of that, Eless is stackable and does not take up large spaces when it comes to storage. Different color choices, decors and seat covers make this barstool an ideal solution for various room situations.

ELESS



922 | 1080 480 480 810 | 823 7,6-8,6 8



4

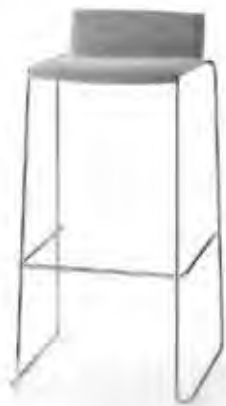

5

Gestell

Rundstahl
verchromt | polyamidbeschichtet
gemäß Hauskollektion

Schale

Formholz
Lack | Beize | Holzfurnier | Schichtstoff
gemäß Hauskollektion

Option

mit und ohne Gleiter erhältlich

Preis

ab EUR 264,-

frame

round steel
chrome-plated | polyamide-coated
according to house collection

shell

molded plywood
varnish | stain | wood veneer | laminate
according to house collection

design option

available with and without gliders

price

from EUR 264,-

SCHALEN . SHELLS

425 | H 922 mm



426 | H 1080 mm



**Schalenkonturen
frei wählbar**

free choice of
shell contours



262



285



279



291



295



281

KARLSSON



-
- 1 Schale mit Vollpolster | Gestell aus Rundstahl, verchromt
fully upholstered shell | frame made of round steel, chrome-plated
 - 2 Schale mit Vollpolster | Gestell aus Rundstahl, verchromt
fully upholstered shell | frame made of round steel, chrome-plated
 - 3 Schale mit Vollpolster | Gestell aus Rundstahl, verchromt
fully upholstered shell | frame made of round steel, chrome-plated



3



KARLSSON



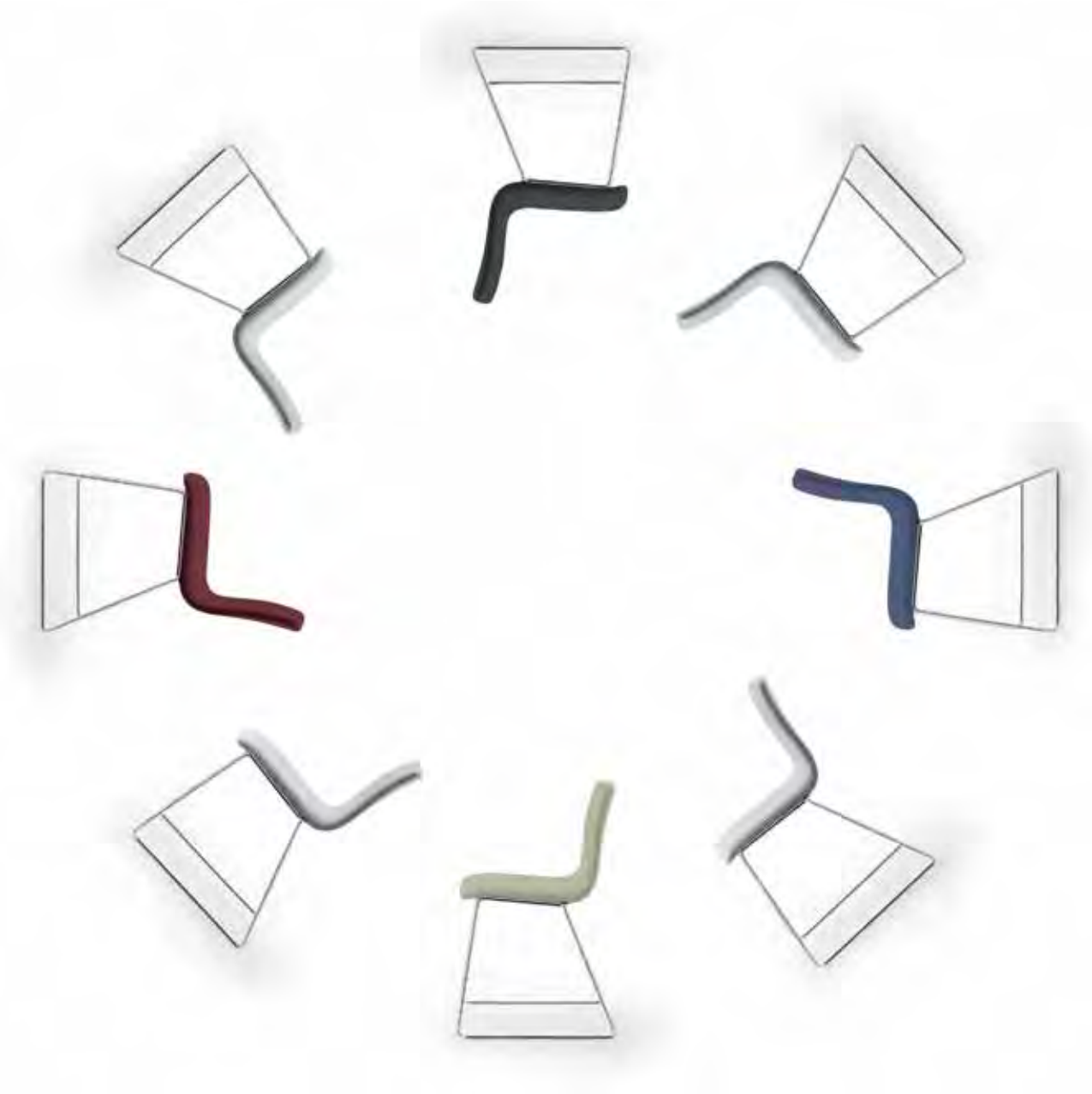

Cool und lässig wirkt Karlsson durch die niedrige Rückenlehne und das filigrane Kufengestell aus verchromtem Vollstahl. Das Vollpolster ermöglicht hohen Sitzkomfort, der strapazierfähige Bezugstoff ist in verschiedenen Farben erhältlich. Karlsson ist der ideale Solitärstuhl für Kurzwarte- und Beratungszonen im Privat- und im Objektbereich.

Karlsson's look is cool and hip, not only because of its lower backrest, but also due to its filigree skid-base frame, designed in chrome-plated steel. The fully upholstered seating shell provides comfortable seating and the durable cover fabric is available in various color options. Karlsson is the perfect stand-alone chair for waiting and consulting areas within private as well as public sectors.

KARLSSON



KARLSSON

					
785	500	500	450	6,5	--

**Gestell**

Rundstahl, verchromt

Schale

Formholz

Polster

Vollpolster

Bezug

Camira Citadel gemäß Hauskollektion

Preis

ab EUR 238,-

frame

round steel, chrome-plated

shell

molded plywood

upholstery

fully upholstered

coverCamira Citadel according
to house collection**price**

from EUR 238,-

Schale mit Vollpolster | Gestell aus Rundstahl, verchromt
fully upholstered shell | frame made of round steel, chrome-plated

AUSFÜHRUNG . DESIGN OPTIONS

Für die Polsterung stehen zahlreiche Farben des Stoffes Citadel von Camira (Stoffklasse 1) zur Auswahl.

Several colors of the fabric Citadel by Camira (fabric class 1) can be chosen for upholstery.



262



285



279



291



295



281

ATICON



1



2

-
- 1 Schwarz gebeizte 3D-Schale | Gestell aus Stahlrohr, verchromt
black stained 3D shell | frame made of steel tube, chrome-plated
 - 2 Schwarz gebeizte 3D-Schale | Gestell aus Stahlrohr, verchromt
black stained 3D shell | frame made of steel tube, chrome-plated
 - 3 2D-Schale mit rotem Schichtstoff belegt | Gestell aus Stahlrohr,
verchromt · 2D shell with red laminate cover | frame made of steel
tube, chrome-plated



3



ATICON

Den Schalenstuhl aticon gibt es mit verschiedenen Sitzschalen sowie mit diversen Polster- und Armlehnenvarianten. Der geringe Rohrdurchmesser des Stahlrohrs sorgt für das filigrane Erscheinungsbild. Durch die optionale Reihenverkettung eignet sich aticon auch für Großveranstaltungen. Die enge Stapelung ermöglicht eine geringe Stapelhöhe. Für aticon stehen neben klassischen 2D- auch ergonomisch geformte 3D-Schalen zur Auswahl.

The shell chair aticon presents itself with diverse shell forms as well as various seat covers and armrest variants. A smaller tube diameter results in a delicate, light appearance. Due to the optional ganging device aticon is perfectly apt for major events. Its space-saving design assures a tight stacking and guarantees a minimum stacking height. Besides classic 2D shells, ergonomic 3D shells may be chosen for aticon.

ATICON



1



2



3

-
- 1 Ungepolstert, mit Armlehnen · without upholstering, with armrests
 - 2 Sitzpolster · seat upholstered
 - 3 Sitz- und Rückenpolster · seat and backrest upholstered
 - 4 Durchgehendes Vorpilster · fully upholstered front
 - 5 Vollpolster · fully upholstered

AUSFÜHRUNG . DESIGN

Die Sitzmöbel sind in vielen verschiedenen Farben, Materialien und Veredelungen erhältlich. Für die Polsterung stehen zahlreiche Stoffe, Leder und Kunstleder zur Verfügung.

The seating furniture is available in various colors, materials and finishings. Several fabrics, leathers and artificial leathers can be chosen for upholstery.

ATICON



830-870 490-560 540-550 460 | 470 5,1-7,1 10



4



5

ARMLEHNEN. ARMRESTS

Polypropylen
polypropyleneStahl
steelMassivholz
solid woodSoftgripschlauch
soft grip tube

SCHALEN . SHELLS



25 | H 870 mm



26 | H 870 mm

— 2D-Schalen | 2D shells —

Schalenkonturen
frei wählbarfree choice of
shell contours

165 | H 845 mm



166 | H 830 mm

— 3D-Schalen | 3D shells —

GestellRundstahlrohr
verchromt | polyamidbeschichtet
gemäß Hauskollektion**Schale**Formholz
Lack | Beize | Holzfurnier | Schichtstoff
gemäß Hauskollektion**Zertifizierung**

GS – Geprüfte Sicherheit | Quality Office

Preis

ab EUR 184,-

frameround steel tube
chrome-plated | polyamide coated
according to house collection**shell**molded plywood
varnish | stain | wood veneer | laminate
according to house collection**certification**

GS – tested safety | Quality Office

price

from EUR 184,-



262



285



279



291



295



281

ATICON

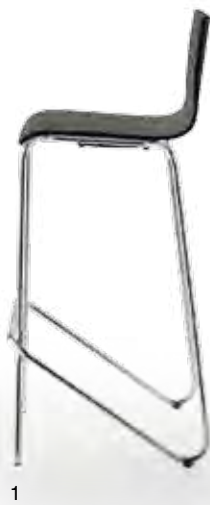

1



2



3

-
- 1 Ungepolstert · without upholstery
 - 2 Sitzpolster · seat upholstered
 - 3 Sitz- & Rückenpolster · seat & backrest upholstered
 - 4 Durchgehendes Vorpolster, gestapelt · fully upholstered front, stacked
 - 5 Vollpolster · fully upholstered

BARHOCKER . BARSTOOL

Der stapelbare aticon Barhocker vereint elegantes Design mit solider Stabilität. Sein filigranes Erscheinungsbild verdankt er vor allem seinen formschön geschwungenen Beinen. Die Farb- und Formgebungs- sowie Polstervariationen der Sitzschale können dem individuellen Raumkonzept angepasst werden.

Not only is the aticon barstool stackable, it also combines elegant design with an extreme stability. Due to its gently curved leg design the barstool gets a filigree, modern look. aticon is an ideal solution for many room situations thanks to the wide range of colors, shapes and upholsteries available.

ATICON



910 | 1080 485 495 - 510 820 6,7-7,5 7



4



5

Gestell

Stahlrohr
verchromt | polyamidbeschichtet
gemäß Hauskollektion

Schale

Formholz
Lack | Beize | Holzfurnier | Schichtstoff
gemäß Hauskollektion

Zertifizierung

GS – Geprüfte Sicherheit

Preis

ab EUR 253,-

frame

steel tube
chrome-plated | polyamide coated
according to house collection

shell

molded plywood
varnish | stain | wood veneer | laminate
according to house collection

certification

GS – tested safety

price

from EUR 253,-

SCHALEN . SHELLS

12 | H 910 mm



13 | H 1080 mm



14 | H 910 mm



15 | H 1080 mm

— 2D-Schalen | 2D shells —



17 | H 1080 mm



18 | H 1080 mm

— 3D-Schalen | 3D shells —



Schalenkonturen

frei wählbar

free choice of
shell contours



262



285



279



291



295



281

GARCIA



1

-
- 1 **MAK Edition: Schale decklackiert | Gestell aus Stahlrohr, verchromt**
MAK edition: varnished shell | frame made of steel tube, chrome-plated
 - 2 **Schale mit Buchefurnier | Gestell aus Stahlrohr, verchromt**
shell with beech veneer | frame made of steel tube, chrome-plated





2



GARCIA

Der Architekt und Designer Martin Mostböck entwickelte mit garcia einen modernen Vierfußstuhl. Zahlreiche Produktvariationen entstehen durch verschiedene Schalenformen und Armlehnentypen, Polstervarianten erhöhen den Sitzkomfort. Dank seines schlichten Designs ist garcia der ideale Konferenzstuhl, eignet sich aber auch für Konzert- und Theaterhäuser. garcia ist auf Wunsch auch als Schwerlaststuhl erhältlich.

Designed by architect Martin Mostböck, garcia has been created as an innovative version of a four-legged chair. Different shell forms and armrest variants offer a wide range of design choices, additional upholstery options enhance the seating comfort. Due to its minimalist design garcia is the perfect contract chair being apt for concert halls as well as theatre locations at the same time. garcia is available with an increased body weight adjustment upon request.

GARCIA



1



2



3

-
- 1 Ungepolstert · without upholstery
 - 2 Sitzpolster · seat upholstered
 - 3 Sitz- und Rückenpolster · seat and backrest upholstered
 - 4 Durchgehendes Vorpilster · fully upholstered front
 - 5 Vollpolster · fully upholstered

AUSFÜHRUNG . DESIGN

Die Sitzmöbel sind in vielen verschiedenen Farben, Materialien und Veredelungen erhältlich. Für die Polsterung stehen zahlreiche Stoffe, Leder und Kunstleder zur Verfügung.

The seating furniture is available in various colors, materials and finishings. Several fabrics, leathers and artificial leathers can be chosen for upholstery.

GARCIA



900 500-570 550 460 5,2-9,0 8-10

Gestell

Rundstahlrohr
verchromt | polyamidbeschichtet
gemäß Hauskollektion

Schale

Formholz
Lack | Beize | Holzfurnier | Schichtstoff
gemäß Hauskollektion

Optionen

Gestell aus verstärktem Stahlrohr (Schwerlaststuhl)

Zertifizierung

ÖNORM

Preis

ab EUR 181,-



4



5

frame

round steel tube
chrome-plated | polyamide-coated
according to house collection

shell

molded plywood
varnish | stains | wood veneer | laminate
according to house collection

design options

frame with reinforced steel tube (heavy weight chair)

certification

ÖNORM

price

from EUR 181,-

ARMLEHNEN. ARMRESTS

200



201



202

SCHALEN . SHELLS

200



201



Schalenkonturen
frei wählbar
free choice of
shell contours



262



285



279



291



295



281

GARCIA



1



2



3

-
- 1 Ungepolstert · without upholstery
 - 2 Sitzpolster · seat upholstered
 - 3 Sitz- und Rückenpolster · seat and backrest upholstered
 - 4 Durchgehendes Vorpolster · fully upholstered front
 - 5 Vollpolster · fully upholstered

BARHOCKER . BARSTOOL

Für den garcia Barhocker mit Vierfußgestell aus stabilem Stahlrohr stehen zwei Holzschalen-Varianten zur Verfügung. Beide können auf Wunsch mit bequemen Polstern ausgestattet werden. Die Fußstütze erhöht den Sitzkomfort.

The garcia barstool with its four-legged frame made of sturdy tubular steel may be ordered with two different types of wooden shells, both of which can be comfortably upholstered upon request. The footrest offers enhanced seating comfort.

GARCIA



910 | 1180 500 490 820 7 --



4



5

Gestell

Rundstahlrohr
verchromt | polyamidbeschichtet
gemäß Hauskollektion

Schale

Formholz
Lack | Beize | Holzfurnier | Schichtstoff
gemäß Hauskollektion

Preis

ab EUR 273,-

frame

round steel tube
chrome-plated | polyamide-coated
according to house collection

shell

molded plywood
varnish | stains | wood veneer | laminate
according to house collection

price

from EUR 273,-

SCHALEN . SHELLS



202 | H 1180 mm



203 | H 910 mm



Schalenkonturen

frei wählbar

free choice of
shell contours



262



285



279



291



295



281

ARKETTO



1



2

-
- 1 **Schwarz gebeizte Schale mit Vorpolster | Gestell aus Stahlrohr, verchromt** · black stained shell with fully upholstered front | frame made of chrome-plated steel tube
 - 2 **Schwarz gebeizte Schale | Gestell aus Stahlrohr, verchromt** · black stained shell | frame made of chrome-plated steel tube
 - 3 **Schwarz gebeizte Schale | Gestell aus Stahlrohr, verchromt** · black stained shell | frame made of chrome-plated steel tube



3



ARKETTO

Eine besonders harmonische Lösung der Reihenverkettung offenbart sich im Stahlrohrstuhl arketto. Die Armlehnen greifen in Form des Yin-Yang-Zeichens ineinander. Dadurch lassen sich die Stühle schnell und unkompliziert übereinander hängen, im Nu ist eine Hallenbestuhlung eingerichtet. Auch als Solitärstuhl macht arketto eine hervorragende Figur.

A particularly elegant creation of an armrest ganging device can be found within the tubular steel chair arketto. Two components shaped like the yin-and-yang symbol interlock and provide a reliable link. As a result arketto provides fast and easy stacking enabling you to set up a hall seating in no time. Moreover, arketto cuts an excellent figure as a stand-alone chair as well.

ARKETTO



1



2



3

-
- 1 Ungepolstert · without upholstery
 - 2 Sitzpolster · seat upholstered
 - 3 Sitz- und Rückenpolster · seat and backrest upholstered
 - 4 Durchgehendes Vorpilster · fully upholstered front
 - 5 Vollpolster · fully upholstered

AUSFÜHRUNG . DESIGN

Die Sitzmöbel sind in vielen verschiedenen Farben, Materialien und Veredelungen erhältlich. Für die Polsterung stehen zahlreiche Stoffe, Leder und Kunstleder zur Verfügung.

The seating furniture is available in various colors, materials and finishings. Several fabrics, leathers and artificial leathers can be chosen for upholstery.

ARKETTO



870 560 520 450 | 460 7-8,5 10-12

Gestell

Rundstahlrohr
verchromt | polyamidbeschichtet
gemäß Hauskollektion

Schale

Formholz
Lack | Beize | Holzfurnier | Schichtstoff
gemäß Hauskollektion

Verkettungselement

Aluminium
kugelgestrahlt | verchromt

Zertifizierung

GS – Geprüfte Sicherheit

Preis

ab EUR 239,-



4



5

ARMLEHNEN. ARMRESTS

Stahl
steel



Kunststoff
plastic



Leder
leather



Holz
wood

SCHALEN . SHELLS

150



151



Schalenkonturen
frei wählbar
free choice of
shell contours

frame

round steel tube
chrome-plated | polyamide-coated
according to house collection

shell

molded plywood
varnish | stains | wood veneer | laminate
according to house collection

ganging device

aluminum
shot-blasted | chrome-plated

certification

GS – tested safety

price

from EUR 239,-



262



285



279



291



295



281

ARKETTO



STAPELUNG . STACKING

Stapelabstand: 40-55 mm
stacking distance: 40-55 mm

Gesamt-Stapelhöhe
12 Stühle, Schale 150: 1500 mm
10 Stühle, Schale 151: 1390 mm

total stacking height
12 chairs, shell 150: 1500 mm
10 chairs, shell 151: 1390 mm



arketto mit Schreibrtablet | arketto with writing tablet



INTELLIGENTE VERKETTUNG INTELLIGENT GANGING DEVICE



HARMONISCHE VERBINDUNG
ELEGANT CONNECTION



SCHNELLE, UNKOMPLIZIERTE VERKETTUNG
FAST AND SIMPLE GANGING



ZWEI BAUTEILE GREIFEN INEINANDER...
TWO INTERLOCKING COMPONENTS CONNECT...



...UND VERBINDEN VORDERFUSSBÜGEL
UND ARMLEHNENBÜGEL.
...FRONT LEG AND ARMREST.

LOGOCHAIR



1



2

-
- 1 Schale mit schwarzem Schichtstoff belegt | Gestell aus Stahlrohr, verchromt · shell with black laminate cover | frame made of steel tube, chrome-plated
 - 2 Schale mit weißem Schichtstoff belegt | Gestell aus Stahlrohr, verchromt, mit Armlehnen · shell with white laminate cover | frame made of steel tube, chrome-plated, with armrests
 - 3 Schale mit Eiche, querfurniert | Stahlrohr, verchromt
shell with horizontally veneered oak | frame made of steel tube, chrome-plated



3



LOGOCHAIR

Die komfortoptimierte 3D-Sitzschale des logochair sorgt für bequemes Sitzen. Bezüglich Material, Farbe oder Dekor stehen viele Möglichkeiten offen. Das Multifunktionselement ermöglicht eine kompakte Stapelung von bis zu 20 Stühlen und dient der Aufnahme von Reihenverbindung, Reihennummerierung und Armlehne. Die Reihenverbindung kann optional auch in paniksicherer Ausführung geliefert werden. Zudem überzeugt der logochair mit seinem guten Preis-Leistungs-Verhältnis.

The 3D shell of logochair is optimized for comfort and ensures relaxed sitting. The multi-functional element provides stacking protection and can be used to attach ganging devices, numeration systems, armrests and writing tablets. The ganging device guarantees safety in combination with extremely easy handling. Optionally, it can be equipped with an anti-panic feature. With its wealth of colors and shapes logochair can be adapted to match any room setting – with compelling value for money.

LOGOCHAIR



1



2



3

-
- 1 Ungepolstert · without upholstery
 - 2 Sitzpolster · seat upholstered
 - 3 Sitz- und Rückenpolster · seat and backrest upholstered
 - 4 Durchgehendes Vorpilster · fully upholstered front
 - 5 Vollpolster · fully upholstered

AUSFÜHRUNG . DESIGN

Die Sitzmöbel sind in vielen verschiedenen Farben, Materialien und Veredelungen erhältlich. Für die Polsterung stehen zahlreiche Stoffe, Leder und Kunstleder zur Verfügung.

The seating furniture is available in various colors, materials and finishings. Several fabrics, leathers and artificial leathers can be chosen for upholstery.

LOGOCHAIR



845-890 505 | 563 550 460 | 470 5,8-8,2 15-20

Gestell

Rundstahlrohr
verchromt | polyamidbeschichtet
gemäß Hauskollektion

Schale

Formholz
Lack | Beize | Holzfurnier | Schichtstoff
gemäß Hauskollektion

Optionen

Reihenverbindung am Multifunktions-
element | ausziehbare Reihenverbindung
beide auch in paniksicherer Ausführung

Zertifizierung

GS – Geprüfte Sicherheit | Quality Office

Preis

ab EUR 133,-



4



5

frame

round steel tube
chrome-plated | polyamide-coated
according to house collection

shell

molded plywood
varnish | stain | wood veneer | laminate
according to house collection

design options

multi-functional element with ganging device |
extractable ganging device
both available with anti-panic system

certification

GS – tested safety | Quality Office

price

from EUR 133,-

SCHALEN . SHELLS



495 | H 845 mm



496 | H 865 mm



497 | H 870 mm



Schalenkonturen
frei wählbar

free choice of
shell contours

495/1 | H 880 mm 496/1 | H 890 mm



262



285



279



291



295



281

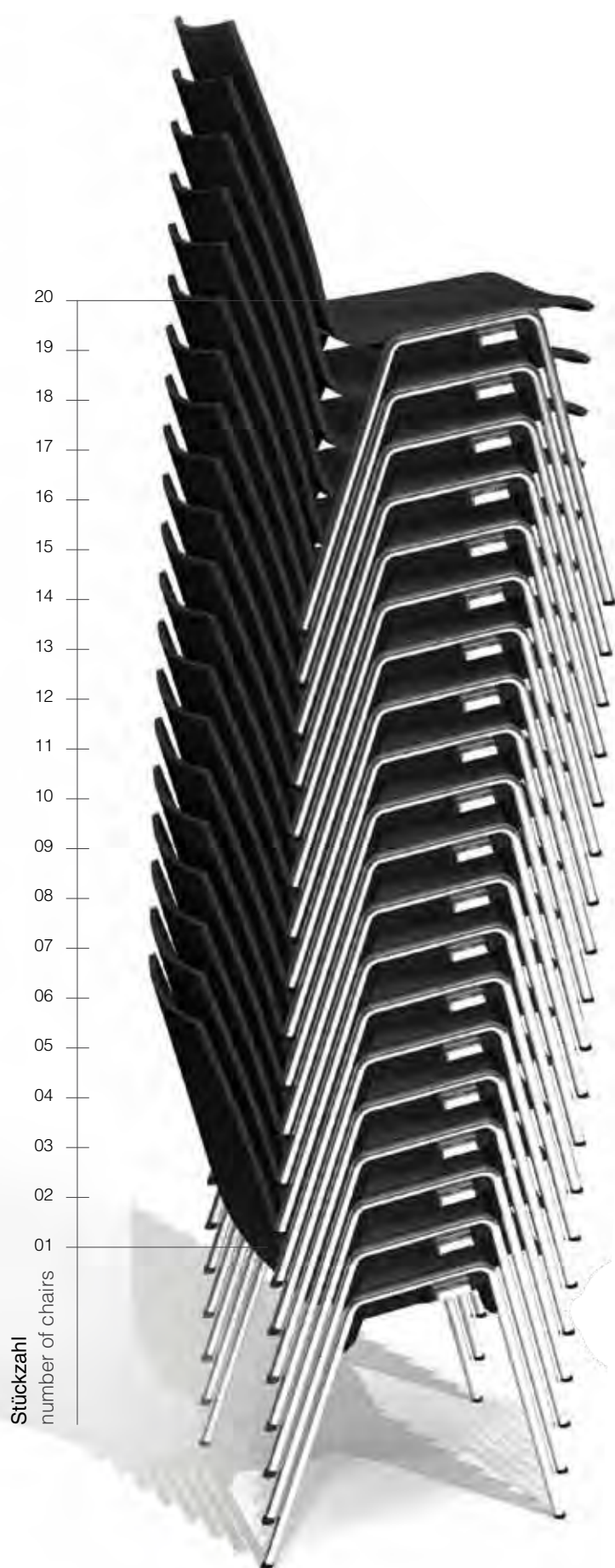

STAPELUNG . STACKING

Stapelabstand: 69 mm
stacking distance: 69 mm

Gesamt-Stapelhöhe: 2350 mm
total stacking height: 2350 mm

PANIKSICHERUNG ANTI-PANIC GANGING DEVICE



RISIKO ERKENNEN: GEFAHR VON
UMGEKIPPTEN STÜHLEN BEI EINER MASSENPANIK

IDENTIFY RISKS: DANGER OF FALLEN
CHAIRS IN CASE OF MASS PANIC

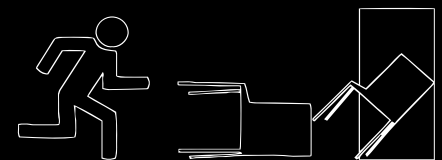

VERSPERRTE FLUCHTWEGE UND STOLPER-
FALLEN KÖNNEN LEBENSGEFÄHRLICH SEIN

DANGER CAUSED BY BLOCKED EVACUATION
ROUTES AND TRIPPING HAZARDS



Armlehnen | armrests



Schreibtablar | writing tablet

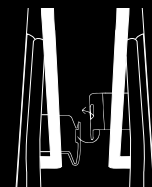

ZUSÄTZLICHE SICHERHEIT DURCH FESTE,
EINFACHE VERBINDUNG DER STÜHLE MIT DER
PANIKSICHEREN REIHENVERBINDUNG

THE ANTI-PANIC GANGING DEVICE OFFERS
ADDITIONAL SECURITY DUE TO THE FIX
AND EASY CONNECTION OF CHAIRS

ARMLEHNEN. ARMRESTS



Stahl
steel



Massivholz
solid wood



Softgripschlauch
soft grip tube

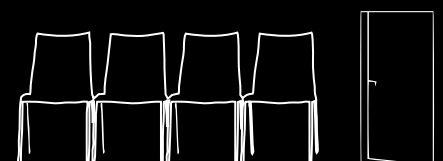

SICHERE VERBINDUNG, DADURCH
MINIMIERUNG DER RISIKEN IM PANIKFALL
SAFE CONNECTION, THEREBY MINIMIZED RISKS
IN CASE OF EMERGENCY

LOGOCHAIR



1



2



3

-
- 1 Ungepolstert · not upholstered
 - 2 Sitzpolster · seat upholstered
 - 3 Sitz- und Rückenpolster · seat and backrest upholstered
 - 4 Durchgehendes Vorpulster · fully upholstered front
 - 5 Vollpolster · fully upholstered

FREISCHWINGER . CANTILEVER CHAIR

Als langlebiger Objektstuhl empfiehlt sich der Freischwinger logochair swing. Die Sitzschale ist in zwei Ausführungen lieferbar und bietet in Verbindung mit dem flexiblen Chromgestell höchste Stabilität. Der logochair Freischwinger ist in vielen Farben und Dekoren, als stapelbare und nicht-stapelbare Variante sowie mit und ohne Rückenbügel erhältlich.

The cantilever logochair is ideal as durable contract seating: the shell, crafted of nine cross-laminated veneer layers, offers ultimate stability together with the highly flexible and filigree chrome frame, while never compromising on design. The cantilever logochair is available in stackable and non-stackable versions.

LOGOCHAIR SWING



840-885 520 570 450 | 465 8,1-10,3 5-6

Gestell

Rundstahlrohr
ZSTE Freischwingerqualität
verchromt | polyamidbeschichtet
gemäß Hauskollektion

Schale

Formholz
Lack | Beize | Holzfurnier | Schichtstoff
gemäß Hauskollektion

Optionen

Armlehnauflage
Massivholz | Kunststoff | Softgripschlauch

Zertifizierung

GS – Geprüfte Sicherheit

Preis

ab EUR 155,-



4



5

GESTELL . FRAME

443
Stapelbar
stackable



445
Nicht stapelbar
non-stackable



442
ohne Rücken-
bügel
without back-
rest bracket



443
mit Rücken-
bügel
with backrest
bracket

RÜCKENBÜGEL . BACKREST**SCHALEN . SHELLS**

442 | H 890 mm



443 | H 840 mm



Schalenkonturen
frei wählbar
free choice of
shell contours

frame

round steel tube
ZSTE cantilever quality
chrome-plated | polyamide-coated
according to house collection

shell

molded plywood
varnish | stain | wood veneer | laminate
according to house collection

design options

armrest cover
solid wood | plastic | soft grip tube

certification

GS – tested safety

price

from EUR 155,-



262



285



279



291



295



281

LOGOCHAIR



-
- 1 Ungepolstert · not upholstered
 - 2 Sitzpolster · seat upholstered
 - 4 Sitz- und Rückenpolster · seat and backrest upholstered
 - 5 Durchgehendes Vorpulster · fully upholstered front
 - 6 Vollpolster, gestapelt · fully upholstered, stacked

BARHOCKER . BARSTOOL

Der stapelbare logochair Barhocker besticht mit seinem filigranen Stahlrohr-Gestell und den formschön gebogenen Beinen. Zwei Sitzschalen stehen zur Auswahl, deren Farbe bzw. Dekor individuell angepasst werden kann. Ob mit oder ohne Polster – hoher Sitzkomfort ist in jedem Fall gegeben.

As a stackable barstool logochair is characterized by its filigree frame made of tubular steel as well as by the attractively curved legs. The logochair barstool offers the choice of two seat variations, both of which may be adjusted individually when it comes to color or decor. Moreover, it offers extraordinary seating comfort due to the either upholstered or not upholstered seat.

LOGOCHAIR

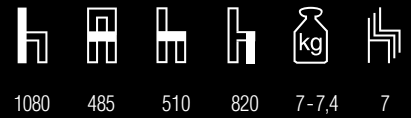

1080

485

510

820

7-7,4

7



4



5

Gestell

Rundstahlrohr
verchromt | polyamidbeschichtet
gemäß Hauskollektion

Schale

Formholz
Lack | Beize | Holzfurnier | Schichtstoff
gemäß Hauskollektion

Preis

ab EUR 253,-

frame

round steel tube
chrome-plated | polyamide-coated
according to house collection

shell

molded plywood
varnish | stain | wood veneer | laminate
according to house collection

price

from EUR 253,-

SCHALEN . SHELLS



17



18



Schalenkonturen
frei wählbar
free choice of
shell contours



262



285



279



291



295



281

LOGOCHAIR



1



2



4

BANK . BENCH

Die logochair Bank ist in Zweier-, Dreier-, Vierer- und Fünferreihen erhältlich. Sie verfügt über ergonomisch geformte Sitzschalen, die selbst lange Wartezeiten angenehm und bequem gestalten. Stabilität wird durch das stabile Stahlrohrgestell erzielt. Bei der Gestaltung kann aus vielen verschiedenen Farben und Formen gewählt werden. Eine optionale Ablage steht ergänzend zur Verfügung.

The logochair bench is available as a two-, three-, four-, or five-seater. Its ergonomically shaped seat shell even makes longer waiting periods pleasant and comfortable. Stability is guaranteed by its solid frame made of tubular steel. A wide range of different colors and shapes can be selected. An optional table tray supplements the bench.

LOGOCHAIR



845-890 970-2560 550 460 | 470



3

Gestell

Rundstahlrohr
verchromt | polyamidbeschichtet
gemäß Hauskollektion
Traverse verchromt

Schale

Formholz
Lack | Beize | Holzfurnier | Schichtstoff
gemäß Hauskollektion

Optionen

Ablagetisch

Preis

ab EUR 592,-

frame

round steel tube
chrome-plated | polyamide coated
according to house collection
chrome-plated traverse

shell

molded plywood
varnish | stain | wood veneer | laminate
according to house collection

design options

table tray

price

from EUR 592,-

- 1 4-Sitzer · 4-seater
2 Beistelltisch | in verschiedenen Größen, Farben und
Dekoren erhältlich · side table | available in various
sizes, colors and decors
3 3-Sitzer · 3-seater
4 5-Sitzer · 5-seater

SCHALEN . SHELLS

495 | H 845 mm



496 | H 865 mm



497 | H 870 mm



Schalenkonturen
frei wählbar

free choice of
shell contours

495/1 | H 880 mm 496/1 | H 890 mm

Polstervarianten siehe logochair Vierfußstuhl, S. 50.

For upholstery variants see logochair four-legged chair, p. 50.



262



285



279



291



295



281

ATLANTA 456



1



2

-
- 1 Schwarze Polypropylenschale | Gestell aus Stahlrohr, verchromt
black polypropylene shell | frame made of steel tube, chrome-plated
 - 2 Signalrote Polypropylenschale | Gestell aus Stahlrohr, verchromt
signal red polypropylene shell | frame made of steel tube, chrome-plated
 - 3 Weiße Polypropylenschale | Gestell aus Stahlrohr, verchromt
white polypropylene shell | frame made of steel tube, chrome-plated



3



ATLANTA 456

atlanta 456 ist die junge Version des Stapelstuhl-Klassikers – frech, trendig, eben einfach anders. Blickfang ist die pflegeleichte, stoßfeste Polypropylen-Schale, die mit ihrer elegant geschwungenen Form, ihrer außergewöhnlichen Oberflächenkombination mit matter Vorderseite und hochglänzender Rückseite und nicht zuletzt mit einer großen Farbauswahl gleich mehrfach punktet.

atlanta 456 is the youthful version of the stacking chair classic – fresh, trendy, simply different. The easy-care, impact-resistant polypropylene shell is a genuine eye-catcher, impressing with its elegantly curved form, its unusual combination of matte front and high-gloss back finishes and last but not least with the wide range of colors available.

ATLANTA 456



Himmelblau
sky blue



Schilfgrün
reed green



Zitrone
lemon



Braun
brown



Silber
silver



Schiefergrau
slate grey

Ungepolstert · not upholstered
Sitzpolster · seat upholstered

ATLANTA 456



825

500

550

470

6,3

15



Reinorange
orange



Signalrot
signal red



Schwarz
black



Weiß
white

Schale

Polypropylen

Vorderseite matt, Rückseite hochglänzend

Gestell

Rundstahlrohr

verchromt | polyamidbeschichtet

gemäß Hauskollektion

mit Stapelsteg oder mit Reihenverbindung

Preis

ab EUR 118,-

shell

polypropylene

textured front, high-gloss back

frame

round steel tube

chrome-plated | polyamide-coated

according to house collection

with stacking bar or with ganging device

price

from EUR 118,-

FARBEN . COLORS

Die Schalen sind in 10 Farben erhältlich.

The shells are available in 10 different colors.



262



285



279



291



295



281

ATLANTA 450



1



2

-
- 1 Schale mit schwarzem Schichtstoff belegt | Gestell aus Stahlrohr, verchromt, mit Stapelsteg · shell with black laminate cover | frame made of steel tube, chrome-plated, with stacking device
 - 2 Schale mit Schichtstoff in "shadow" belegt | Gestell aus Stahlrohr, verchromt · shell with laminate cover "shadow" | frame made of steel tube, chrome-plated
 - 3 Schale mit Buchefurnier, gebleicht | Gestell aus Stahlrohr, verchromt
shell with bleached beech veneer | frame made of steel tube, chrome-plated



3



ATLANTA 450

Der Vierfußstuhl atlanta erfuhr in seiner Weiterentwicklung eine formale Verfeinerung, wodurch atlanta 450 deutlich filigraner wirkt. Die 10 mm dünne, neunfach verleimte Sitzschale ermöglicht komfortables, ergonomisches Sitzen. Die besonders hohe Stapelung von bis zu 20 Stühlen ist ein weiterer Pluspunkt. Mit ihrem großen Farb- und Formenreichtum passen sich die Stühle vielen Raumsituationen an.

atlanta experienced a formal refinement in design that led to the development of atlanta 450, an evolutionary process that left the chair significantly more filigree. The 10 mm thin shell, crafted from nine laminated layers, offers ergonomic seating comfort. The extraordinary stacking capacity of up to 20 chairs is an additional benefit. The chair serves as an ideal solution for many room situations thanks to the wide range of colors and shapes available.

ATLANTA 450



1



2



3

-
- 1 Ungepolstert · without upholstery
 - 2 Sitzpolster · seat upholstered
 - 3 Sitz- und Rückenpolster · seat and backrest upholstered
 - 4 Durchgehendes Vorpulster · fully upholstered front
 - 5 Vollpolster · fully upholstered

AUSFÜHRUNG . DESIGN OPTIONS

Die Sitzmöbel sind in vielen verschiedenen Farben, Materialien und Veredelungen erhältlich. Für die Polsterung stehen zahlreiche Stoffe, Leder und Kunstleder zur Verfügung.

The seating furniture is available in various colors, materials and finishings. Several fabrics, leathers and artificial leathers can be chosen for upholstery.

ATLANTA 450



845-890 501-570 550 460|470 5,8-8,2 15-20



4



5

Gestell

Rundstahlrohr
verchromt | polyamidbeschichtet
nach Hauskollektion

Schale

Formholz
Lack | Beize | Holzfurnier | Schichtstoff
gemäß Hauskollektion

Zertifizierung

GS – Geprüfte Sicherheit | Quality Office

Preis

ab EUR 112,-

frame

round steel tube
chrome-plated | polyamide coated
according to house collection

shell

plywood
varnish | stain | wood veneer | laminate
according to house collection

certificates

GS – tested safety | Quality Office

price

from EUR 112,-

SCHALEN . SHELLS

495 | H 845 mm



496 | H 865 mm



497 | H 870 mm



Schalenkonturen
frei wählbar

free choice of
shell contours

495/1 | H 880 mm 496/1 | H 890 mm



262



285



279



291



295



281

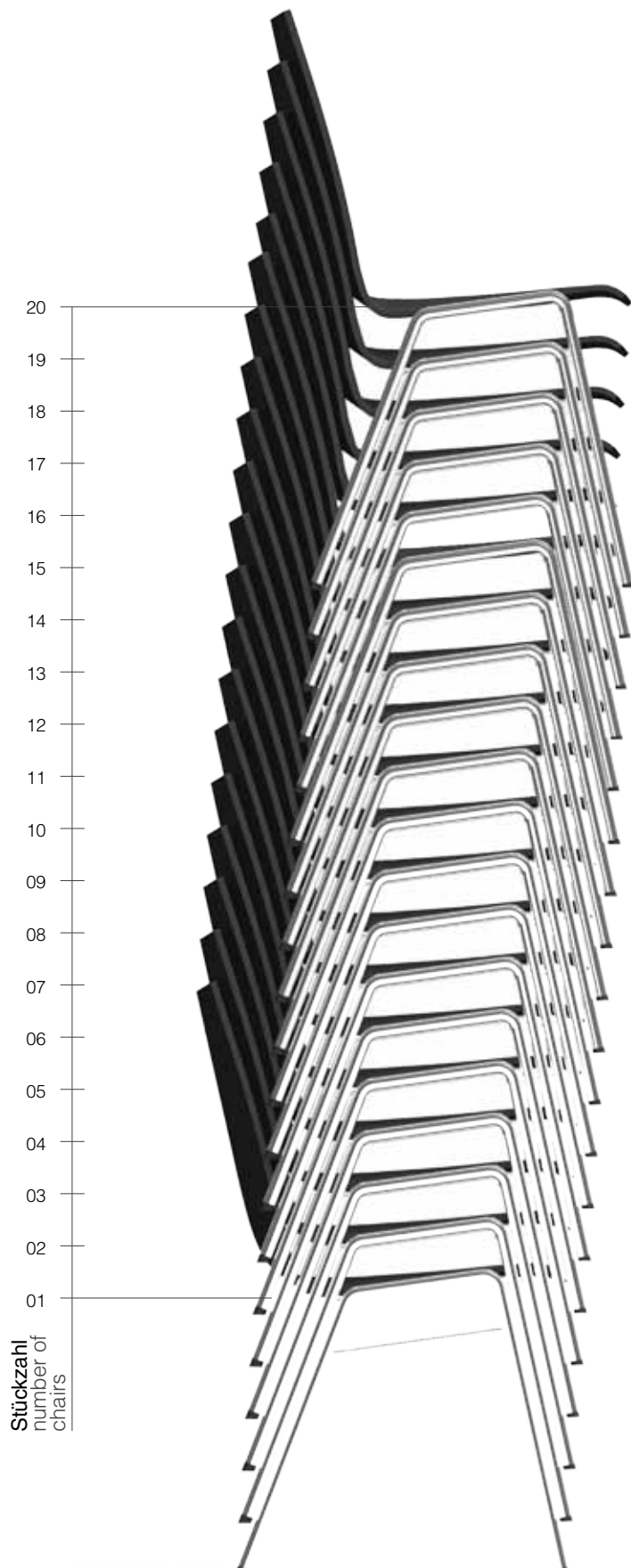

STAPELUNG . STACKING

Stapelabstand: 65 - 69 mm
stacking distance: 65 - 69 mm

Gesamt-Stapelhöhe 20 Stück: 2350 mm
total stacking height 20 chairs: 2350 mm

ATLANTA 450



ARMLEHNEN. ARMRESTS



Stahl
steel



Massivholz
solid wood



Softgripschlauch
soft grip tube

-
- 1 Armlehne | armrest
 - 2 Schreibratlar | writing tablet
 - 3 Stapelsteg mit Krallen-Reihenverbindung
stacking device with claw ganging device
 - 4 Stapelsteg mit Reihenverbindung 'Elegance'
stacking device with ganging device 'elegance'

ATLANTA 55 | 66 | 67



1



2

-
- 1 Schale mit Buchefurnier | Gestell aus Stahlrohr, verchromt
shell with beech veneer | frame made of steel tube, chrome-plated
 - 2 Schwarz gebeizte Schale | Gestell aus Stahlrohr, verchromt
black stained shell | frame made of steel tube, chrome-plated
 - 3 Schwarz gebeizte Schale | Gestell aus Stahlrohr, verchromt
black stained shell | frame made of steel tube, chrome-plated



3



ATLANTA

atlanta ist ein echter Klassiker, ob als Vierfußstuhl oder als Freischwinger. Große Variationsvielfalt und ein hervorragendes Preis-Leistungs-Verhältnis – dafür steht atlanta bereits seit Jahren. Die Formholzschale kann (deck-)lackiert, gebeizt oder mit Schichtstoff belegt werden und eröffnet damit ein breites Gestaltungsspektrum. Die Stapelbarkeit sowie die optionale Reihenverbindung machen atlanta zum idealen Stuhl für Mehrzweckhallen und Veranstaltungsräume.

Whether as four-legged chair or as cantilever chair: atlanta is a veritable design classic. A huge variety of designs and an outstanding price-performance ratio have been its characteristics for years. The molded wooden shell can be varnished, stained, or coated with laminate and thus offers a wide range of design choices. atlanta can be stacked easily and contains the option of a ganging device, which makes this chair the ideal solution for multi-purpose halls and event premises.

ATLANTA 55



1



2



3

-
- 1 Ungepolstert · without upholstery
 - 2 Sitzpolster · seat upholstered
 - 3 Sitz- und Rückenpolster · seat and backrest upholstered
 - 4 Durchgehendes Vorpilster · fully upholstered front
 - 5 Vollpolster · fully upholstered

AUSFÜHRUNG . DESIGN OPTIONS

Die Sitzmöbel sind in vielen verschiedenen Farben, Materialien und Veredelungen erhältlich. Für die Polsterung stehen zahlreiche Stoffe, Leder und Kunstleder zur Verfügung.

The seating furniture is available in various colors, materials and finishings. Several fabrics, leathers and artificial leathers can be chosen for upholstery.

ATLANTA 55



880 510-640 560 460 | 470 5,2-6,7 10



4



5

ARMLEHNEN. ARMRESTS



36



55

SCHALEN . SHELLS



40



59



79



Schalenkonturen
frei wählbar
free choice of
shell contours

Gestell

Rundstahlrohr
verchromt | polyamidbeschichtet
gemäß Hauskollektion
mit Stapelsteg

Schale

Formholz
Lack | Beize | Holzfurnier | Schichtstoff
gemäß Hauskollektion

Zertifiziert

GS – Geprüfte Sicherheit | Quality Office

Preis

ab EUR 115,-

frame

round steel tube
chrome-plated | polyamide-coated
according to house collection
with stacking bar

shell

plywood
varnish | stain | wood veneer | laminate
according to house collection

certificates

GS – tested safety | Quality Office

price

ab EUR 115,-



262



285



279



291



295



281

ATLANTA 66 | 67



1



2



3

-
- 1 atlanta 66 | ungepolstert · without upholstery
 - 2 atlanta 67 | Sitzpolster · seat upholstered
 - 3 atlanta 67 | Sitz- und Rückenpolster · seat and backrest upholstered
 - 4 atlanta 67 | durchgehendes Vorpolster · fully upholstered front
 - 5 atlanta 67 | Vollpolster · fully upholstered

AUSFÜHRUNG . DESIGN OPTIONS

Die Sitzmöbel sind in vielen verschiedenen Farben, Materialien und Veredelungen erhältlich. Für die Polsterung stehen zahlreiche Stoffe, Leder und Kunstleder zur Verfügung.

The seating furniture is available in various colors, materials and finishings. Several fabrics, leathers and artificial leathers can be chosen for upholstery.

ATLANTA 66 | 67



870 540 590 460 | 470 5,8-8,7 8-10



4



5

Gestell

atlanta 66: Freischwinger ohne Armlehnen

atlanta 67: Freischwinger mit Armlehnen

Rundstahlrohr

verchromt | polyamidbeschichtet

gemäß Hauskollektion

Schale

Formholz

Lack | Beize | Holzfurnier | Schichtstoff

gemäß Hauskollektion

Preis

ab EUR 147,-

frame

atlanta 66: cantilever chair without armrests

atlanta 67: cantilever chair with armrests

round tube steel

chrome-plated | polyamide-coated

according to house collection

shell

plywood

varnish | stain | wood veneer | laminate

according to house collection

price

from EUR 147,-

SCHALEN . SHELLS



40



59



79

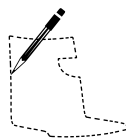

Schalenkonturen

frei wählbar

free choice of

shell contours



262



285



279



291



295



281

LISTO



- 1 Sitz und Rücken schwarz gebeizt | Gestell aus Stahlrohr, schwarz polyamidbeschichtet · black stained seat and backrest | frame made of steel tube, polyamide-coated in black
- 2 Sitz und Rücken schwarz gebeizt | Gestell aus Stahlrohr, verchromt · black stained seat and backrest | frame made of steel tube, chrome-plated
- 3 Sitz mit Vollpolster, Rücken mit Eichefurnier | Gestell aus Stahlrohr, verchromt · fully upholstered seat, backrest with oak veneer | frame made of steel tube, chrome-plated



3



LISTO

Der Zweiteiler listo trumpft als System mit verschiedenen Sitz- und Rückenformen sowie Armlehnenvarianten auf. Die enge Stapelung ermöglicht eine geringe Stapelhöhe, somit benötigt listo wenig Platz bei der Lagerung. Das Stahlrohrgestell verleiht dem Stuhl eine hohe Stabilität und eine lange Lebensdauer. listo ist reihenverkettbar und dadurch auch für Großveranstaltungen geeignet.

The two-piece item listo shows off as a system with various seat and backrest forms and armrest variants. Its tight stacking guarantees a minimum stacking height and moreover occupies minimum storage space. Extreme stability and a long lifespan are guaranteed by the use of a solid tubular steel frame. listo possesses a linkable frame. Therefore it is perfectly apt for major events.

LISTO



-
- 1 Ungepolstert · without upholstery
 - 2 Sitzpolster · seat upholstered
 - 3 mit Armlehnen und Sitzpolster · with armrests and upholstered seat
 - 4 Vorpilster und Sitzpolster · upholstered front and seat
 - 5 Vollpolster und Sitzpolster · fully upholstered seat and backrest

AUSFÜHRUNG . DESIGN OPTIONS

Die Sitzmöbel sind in vielen verschiedenen Farben, Materialien und Veredelungen erhältlich. Für die Polsterung stehen zahlreiche Stoffe, Leder und Kunstleder zur Verfügung.

The seating furniture is available in various colors, materials and finishings. Several fabrics, leathers and artificial leathers can be chosen for upholstery.

LISTO

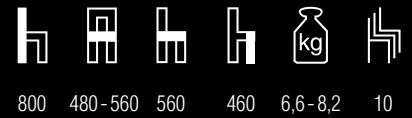

800 480-560 560 460 6,6-8,2 10



4



5

Gestell

Rundstahlrohr
verchromt | polyamidbeschichtet
gemäß Hauskollektion

Sitz und Rücken

Formholz
Lack | Beize | Holzfurnier | Schichtstoff
gemäß Hauskollektion

Zertifizierung

ÖNORM

Preis

ab EUR 182,-

frame

round steel tube
chrome-plated | polyamide-coated
according to house collection

seat and backrest

plywood
varnish | stains | wood veneer | laminate
according to house collection

certification

ÖNORM

price

from EUR 182,-

ARMLEHNEN. ARMRESTS

Massivholz
solid wood



Softgripschlauch
soft grip tube

SITZ- & RÜCKENFLÄCHEN . SEATS & BACKRESTS

210 | H 770 mm



211 | H 800 mm



210
Wasserfallkante
waterfall edge



211
gerade Sitzfläche
straight seat



262



285



279



291



295



281

BONNIE & CLYDE



1



2

-
- 1 clyde | Buche schwarz gebeizt, mit Armlehnen und Sitzpolster
beech, black stained, with armrests and seat upholstery
 - 2 clyde | Buche schwarz gebeizt, mit Armlehnen und Sitzpolster
beech, black stained, with armrests and seat upholstery
 - 3 bonnie | Buche schwarz gebeizt, mit 1 Rückensprosse
beech, black stained, with 1 muntin



3



BONNIE & CLYDE

Wie das berühmte Gangsterduo bildet auch das Holzstuhl-Doppel bonnie & clyde ein gutes Gespann. Als Unterscheidungsmerkmal dient der Hinterfuß, welcher bei bonnie elegant gebogen ist. clyde ist mit seinem kantigen Hinterfuß der markantere der beiden Holzstühle. Unterschiedliche Rückenformen, verschiedene Polstervarianten und zahlreiche Farben sorgen für individuelle Gestaltungsmöglichkeiten.

Just like the famous criminal couple the wooden chair duo bonnie & clyde is a perfect match as well. bonnie's rear leg is elegantly curved and serves as a distinctive feature. With its angular back leg clyde is the more masculine part of the duo. Different back versions, various choices of upholstery as well as numerous colors offer countless possibilities when it comes to design options.

BONNIE & CLYDE



1

BONNIE

-
- 1 bonnie** | Buche decklackiert, schwarz matt | Armlehne 360
beech, matte black varnish | armrest 360
 - 2 clyde** | Buche decklackiert, schwarz matt | Armlehne 370
beech, matte black varnish | armrest 370

Beide Armlehnenvarianten sind für alle Modelle bonnie 360 und alle Modelle clyde 370 erhältlich.
Both armrest variants are available for all bonnie 360 and clyde 370 chairs.

BONNIE & CLYDE



820 480-555 510 455-475 3,4-4,9 8-10



2

CLYDE

AUSFÜHRUNG . DESIGN

Die Sitzmöbel sind in vielen verschiedenen Farben, Materialien und Veredelungen erhältlich. Für die Polsterung stehen zahlreiche Stoffe, Leder und Kunstleder zur Verfügung.

The seating furniture is available in various colors, materials and finishings. Several fabrics, leathers and artificial leathers can be chosen for upholstery.

Gestell

Buche massiv | Eiche massiv
Lack | Beize gemäß Hauskollektion
Rahmen fingerverzinkt, Verleimfräsung

Sitz

Formholz
Lack | Beize gemäß Hauskollektion

Rücken

Formholz | gebogenes Massivholz
mit 1 oder 2 Sprossen
Lack | Beize gemäß Hauskollektion

Zertifizierung

ÖNORM

Preis

ab EUR 245,-

frame

solid beech | solid oak
varnish | stains according to house collection
finger-jointed frame, glued milling

seat

plywood
varnish | stains according to house collection

backrest

plywood | bended solid wood
with 1 or 2 muntins
stains according to house collection

certification

ÖNORM

price

from EUR 245,-



262



285



279



291



295



281

VARIANTEN . VARIANTS



1



2

-
- 1 Rücken 360 | durchgehender Rücken · backrest 360 | one-piece backrest
 - 2 Rücken 363 | eingelassener Rücken mit einer Sprosse · backrest 363 | embedded backrest with one muntin
 - 3 Rücken 361 | Rücken mit einer Sprosse · backrest 361 | backrest with one muntin
 - 4 Rücken 364 | tiefer Rücken mit einer Sprosse · backrest 364 | low backrest with one muntin
 - 5 Rücken 362 | Rücken mit zwei Sprossen · backrest 362 | backrest with two muntins

Alle Rückenvarianten sind als Modell **bonnie** und als Modell **clyde** erhältlich.

All backrest variants are available for both chairs, **bonnie** and **clyde**.

BONNIE & CLYDE



3



4



5



CLYDE



BARHOCKER . BARSTOOL

Der clyde Barhocker mit seinem Gestell aus massivem Holz zeichnet sich durch seine markante Form aus. Komfortables Sitzen ermöglicht die Rückenlehne, durch ein optionales Polster kann der Sitzkomfort noch erhöht werden. Verschiedene Massivhölzer und diverse Farben stehen zur Verfügung.

The frame of the clyde barstool is manufactured of solid wood. It is characterized by its masculine, striking appearance. The back seat guarantees comfortable seating, the optional choice of an upholstered seat enhances seating comfort. Various solid woods and colors are provided for your selection.

CLYDE

					
1060	410	860	840 - 850	5,3	--



1



2

- 1 ungepolstert · not upholstered
2 Sitzpolster · seat upholstered

Gestell

Buche massiv | Eiche massiv
Lack | Beize gemäß Hauskollektion
Rahmen fingerverzinkt
Holzverbindungen mit Verleimfräsung

Sitz

Formschichtholz
Lack | Beize | Holzfurnier gemäß Hauskollektion

Rücken

gebogenes Massivholz mit 1 Sprosse

Preis

ab EUR 393,-

frame

solid beech | solid oak
varnish | stains according to house collection
finger-jointed frame
wood connections with glued milling

seat

molded plywood
varnish | stains | wood veneer
according to house collection

backrest

bended solid wood with 1 muntin

price

from EUR 393,-



262



285



279



291



295



281

CLYDE



BANK . BENCH

Das charakteristische markante Design wurde in der clyde Sitzbank fortgeführt. Die clyde Bank verfügt über ein Gestell aus massivem Holz und bietet dementsprechend eine solide Stabilität.

The characteristic design has been maintained within the conception of the clyde bench. The bench's frame consists of solid wood and thus offers a reliable stability.

CLYDE



830 1100 490 450-475 9,6-11,5 --



2



3

- 1 ungepolstert · not upholstered
 2 Sitzpolster · seat upholstered
 3 Sitz- und Rückenpolster · seat and backrest upholstered

Gestell

Buche massiv | Eiche massiv
 Lack | Beize gemäß Hauskollektion
 Rahmen fingerverzinkt
 Holzverbindungen mit Verleimfräsung

Sitz

Formschichtholz
 Lack | Beize | Holzfurnier gemäß Hauskollektion

Rücken

1 Sprosse und Formschichtholz

Preis

ab EUR 481,-

frame

solid beech | solid oak
 varnish | stains according to house collection
 finger-jointed frame
 wood connections with glued milling

seat

molded plywood
 varnish | stains | wood veneer
 according to house collection

backrest

1 muntin and molded plywood

price

from EUR 481,-



262



285



279



291



295



281

CLYDE



1

-
- 1 Tischplatte mit schwarzem HPL belegt | Gestell Buche massiv · table top with black HPL cover | frame made of solid beech
 - 2 Tischplatte Buche, furniert | Gestell Buche massiv
table top with beech veneer | frame made of solid beech

TISCH . TABLE

Stabil, formschön, mit vielen Gestaltungsmöglichkeiten – so zeigt sich der zur bonnie & clyde Kollektion gehörige Holztisch clyde. Das massive Holzgestell und die mit hochwertigem HPL beschichtete Tischplatte sorgen für soliden Stand und eine lange Lebensdauer. Gestaltungsfreiheit entsteht durch verschiedene Farben und Dekore.

Solid, elegant, an item with numerous design possibilities: this is clyde, the collection's very own wooden table. Its distinctive features, a massive wooden frame combined with a table top coated with high-quality HPL, ensure a solid standing and a maximum lifespan. The use of different colors and decors provides an enormous flexibility when it comes to design options.

CLYDE

Tischhöhe

740 mm

Gestell

Buche massiv | Eiche massiv | Ahorn massiv
Lack | Beize gemäß Hauskollektion
Stollen einseitig abgeschrägt

Tischplatte

Spanplatte
Buche | Eiche | Ahorn furniert
Lack | Beize | HPL
gemäß Hauskollektion

Kantenprofil

ABS-Umleimer

Preis

ab EUR 565,-



2

GRÖSSEN . SIZES

quadratisch
square

600 x 600 mm
700 x 700 mm
800 x 800 mm



rechteckig
rectangular

700 - 1400 mm x 600 mm
800 - 1800 mm x 700 mm
900 - 1800 mm x 800 mm

height

740 mm

frame

solid beech | solid oak | solid maple
varnish | stains according to house collection
legs unilaterally aligned

table top

chipboard
beech | oak | maple veneer
varnish | stains | HPL
according to house collection

edge profile

ABS edge

price

from EUR 565,-



262



285



279



291



295



281

PAN



1



2

-
- 1 Schale 390, mit Armlehnen, Esche natur, Vollpolster
shell 390, with armrests, natural ash, fully upholstered
 - 2 Schale 390, mit Armlehnen, Buche natur
shell 390, with armrests, natural beech
 - 3 Schale 391, Buche, schwarz gebeizt
shell 391, beech, stained in black



3



PAN

Charakteristisches Merkmal der PAN Holzstühle ist der puristische Look. Verschiedene Schalenformen, optionale Armlehnen sowie verschiedene Polster- und Farbvarianten geben Individualität. Objektauglich wird PAN durch Features wie Stapelbarkeit, eine optionale Auszieh-Reihenverbindung oder eine Reihen- oder Platznummerierung auf Kundenwunsch.

The PAN chair collection stands out by its pure, clean look. Different shell variants, an optional addition of armrests as well as numerous choices of colors and upholstery help to maintain individuality. PAN fits perfectly into a professional object area due to its key features like stacking capacity, an optional pull-out ganging device and row or seat numbering according to customer specifications.

PAN



1



2



3

-
- 1 Schale 390 | ungepolstert · shell 390 | without upholstery
 - 2 Schale 390 | Sitzpolster · shell 390 | seat upholstered
 - 3 Schale 390 | Sitz- und Rückenpolster · shell 390 | seat and backrest upholstered
 - 4 Schale 390 | Durchgehendes Vorpilster · shell 390 | fully upholstered front
 - 5 Schale 390 | Vollpolster · shell 390 | fully upholstered

AUSFÜHRUNG . DESIGN OPTIONS

Die Sitzmöbel sind in vielen verschiedenen Farben, Materialien und Veredelungen erhältlich. Für die Polsterung stehen zahlreiche Stoffe, Leder und Kunstleder zur Verfügung.

The seating furniture is available in various colors, materials and finishings. Several fabrics, leathers and artificial leathers can be chosen for upholstery.

PAN



830 | 860 510 540 460-470 5,8-7,2 4



4



5

Gestell

Buche massiv | Eiche massiv | Esche massiv
Lack | Beize gemäß Hauskollektion

Schale

Formschichtholz
Furnier | Lack | Beize | Schichtstoff
gemäß Hauskollektion

Preis

ab EUR 212,-

frame

solid beech | solid oak | solid ash
varnish | stains according to house collection

shell

molded plywood
wood veneer | varnish | stains | laminate
according to house collection

price

from EUR 212,-

ARMLEHNEN. ARMRESTS

Armlehne 390
ungepolstert
armrest 390
not upholstered



Armlehne 391
gepolstert
armrest 391
upholstered



262



285



279



291



295



281

PAN



SCHALEN . SHELLS



Schale 391 | H 860 mm
shell 391 | h 860 mm



Schale 390 | H 830 mm
shell 390 | h 830 mm



Schale 392 | H 830 mm
shell 392 | h 830 mm

HOCHLEHNER . HIGH-BACK CHAIR



Schale 395 | H 920 mm
shell 395 | h 920 mm



Schale 396 | H 1150 mm
shell 396 | h 1150 mm



Schale 397 | H 1250 mm
shell 397 | h 1250 mm

PAN Hochlehner | mit und ohne Armlehnen erhältlich | Polstervarianten siehe Seite 94.

PAN high-back chair | available with and without armrests | for upholstery variants see page 94.

PAN



FAUTEUIL . FAUTEUIL

Der PAN Fauteuil verspricht Sicherheit und Wohlfühlen. Das breite Massivholzgestell verleiht dem Sessel die Extra-Portion Stabilität, die optionalen Armlehnen erleichtern das Aufstehen. Verschiedene Polstervarianten sowie die Möglichkeit der Komfortpolsterung erhöhen den Sitzkomfort. Damit eignet sich der PAN Fauteuil ideal für Care-Bereiche.

The PAN fauteuil promises safety and well-being. The wide frame made of solid wood gives an extra portion of stability, optional armrests provide support when standing up and sitting down. Various upholstery variants as well as an optional comfort upholstery provide high seating comfort. Thus, PAN armchair is ideal for care institutions.

PAN



880 580 595 420-430 9,2-10,2 2



4



5

Gestell

Buche massiv | Eiche massiv | Esche massiv
Lack | Beize gemäß Hauskollektion

Schale

Formschichtholz
Holzfurnier | Lack | Beize | Schichtstoff
gemäß Hauskollektion

Preis

ab EUR 248,-

- 1 mit Komfortpolster · with comfort upholstery
2 mit Armlehnen und Komfortpolster · with armrests and comfort upholstery
3 Hocker | Vorstellisch, auch in gepolsterter Ausführung erhältlich · stool | side table, upholstered variants available
4 mit Komfortpolster · with comfort upholstery
5 mit Armlehnen und Komfortpolster · with armrests and comfort upholstery

frame

solid beech | solid oak | solid ash
varnish | stains according to house collection

shell

molded plywood
wood veneer | varnish | stains | laminate
according to house collection

price

from EUR 248,-

ARMLEHNEN. ARMRESTS

Armlehne 392
ungepolstert
armrest 392
not upholstered



Armlehne 393
gepolstert
armrest 393
upholstered

Polstervarianten siehe PAN Vierfußstuhl, S. 94.
For upholstery variants see PAN four-legged chair, p. 94.



262

285

279

291

295

281

PAN



-
- 1 Ungepolstert · not upholstered
 - 2 Sitzpolster · seat upholstered
 - 3 Sitz- und Rückenpolster · seat and backrest upholstered
 - 4 Durchgehendes Vorpulster · fully upholstered front
 - 5 Vollpolster · fully upholstered

BARHOCKER . BARSTOOL

Die ideale Ergänzung zur PAN Serie ist der PAN Barhocker. Das charakteristische minimalistische Design des Vierfußstuhls wurde auch in der Gestaltung des Barhockers fortgesetzt. Zwei Schalenformen mit oder ohne Sitzpolster schaffen Gestaltungsspielraum.

The ideal supplement to the PAN series is the PAN barstool. The characteristic minimalist design of the four-legged chair was continued in the design of the barstool. Two shell forms with or without upholstery give a wide choice of design options.

PAN



980 | 1060 420 490 830 - 840 5,3 - 6,5 --



4



5

Gestell

Buche massiv | Eiche massiv | Esche massiv

Schale

Formschichtholz
Furnier | Lack | Beize | Schichtstoff
gemäß Hauskollektion

Optionen

weitere Komfortschalen erhältlich

Preis

ab EUR 365,-

frame

solid beech | solid oak | solid ash

shell

molded plywood
veneer | varnish | stains | laminate
according to house collection

design options

further comfort shells available

price

from EUR 365,-

SCHALEN . SHELLS

393 | H 980 mm



393/1 | H 1060 mm



262



285



279



291



295



281

PAN



1

BANK . BENCH

Die perfekte Lösung für Kurzwartebereiche ist die PAN Bank. Zwei Personen finden auf ihr Platz. Zahlreiche Gestaltungsmöglichkeiten entstehen durch diverse Polstervarianten, optionale Armlehnen und Ablageflächen.

The PAN bench is the perfect solution for waiting areas offering space for two persons. Diverse upholstery possibilities, optional armrests and trays offer numerous design options.

PAN

					
860	510	540	460-470	9-12	--



2



3

Gestell

Buche massiv | Eiche massiv | Esche massiv
Lack | Beize gemäß Hauskollektion

Schale

Formschichtholz
Furnier | Lack | Beize | Schichtstoff
gemäß Hauskollektion

Preis

ab EUR 505,-

frame

solid beech | solid oak | solid ash
varnish | stains according to house collection

shell

molded plywood
veneer | varnish | stains | laminate
according to house collection

price

from EUR 505,-

-
- 1 mit Armlehnen, ungepolstert · with armrests, not upholstered
2 ohne Armlehnen, mit Vorpöster · without armrests, fully upholstered front
3 mit Armlehnen, ungepolstert, mit Tischablage · with armrests, not upholstered, with table element

Polstervarianten siehe PAN Vierfußstuhl, S. 94.
For upholstery variants see PAN four-legged chair, p. 94.



PAN



-
- 1 Gestell Buche, gebeizt | Tischplatte Buche, gebeizt · frame made of solid beech, stained | table top stained beech
 - 2 Gestell aus Buche, natur lackiert | Tischplatte mit HPL belegt · frame made of solid beech, natural varnished | table top with HPL cover

TISCH . TABLE

Der PAN Tisch besteht aus einem Vierfußgestell aus massiver Buche, Eiche oder Esche, das analog zum Stuhlgestell (deck-)lackiert oder gebeizt werden kann, und einer mit hochwertigem Holz furnier oder mit HPL belegten Tischplatte. Alternativ kann eine matt decklackierte Tischplatte gewählt werden. Der PAN Holztisch ist in verschiedenen Größen, Farben und Dekoren sowie mit diversen Kantenprofilen erhältlich.

As a table, PAN is manufactured from massive beech, oak or ash tree wood. It consists of a four-leg frame that may be varnished or stained and a table top that may be either coated with HPL or high quality veneer. Alternatively, the table top can be chosen in a matte varnish finish. The PAN wooden table is available in various sizes, color options and decors and can be equipped with different edge profiles.

PAN



2

GRÖSSEN . SIZES



quadratisch
square

600 x 600 mm
700 x 700 mm
800 x 800 mm
900 x 900 mm



rechteckig
rectangular

700-2000 mm x 600 mm
800-2000 mm x 700 mm
900-2000 mm x 800 mm

Tischhöhe

740 mm

Gestell

Buche massiv | Eiche massiv | Esche massiv
Lack | Beize gemäß Hauskollektion

Tischplatte

Spanplatte

Lack | Beize | Holzfurnier | HPL
gemäß Hauskollektion

Kantenprofile

ABS Umleimer | Massivholzeinleimer
Beize gemäß Hauskollektion

Preis

ab EUR 375,-

table height

740 mm

frame

solid beech | solid oak | solid ash
varnish | stains according to house collection

table top

raw chipboard

varnish | stains | wood veneer | HPL
according to house collection

edge profiles

ABS edge | solid wood edge
stains according to house collection

price

from EUR 375,-



262



279



291



281

ELENA



1



2

-
- 1 **Schwarz decklackiert**
varnished in black
 - 2 **Schwarz decklackiert | Sitzpolster**
varnished in black | upholstered seat
 - 3 **Schwarz decklackiert**
varnished in black



3



ELENA

Das Besondere am Holzstuhl elena ist der verwindungsfähige Schichtholzrahmen GenioFlex. Er entlastet die Verbindungsstellen des Rahmens und sorgt so für einen selbsttätigen Ausgleich von Bodenunebenheiten. Dadurch erhält der elena Vierfußstuhl eine extrem hohe Lebensdauer. Eine enorme Variantenvielfalt entsteht durch diverse Polsterungen, Armlehnen und Rückenformen.

elena's specific feature is its flexible laminated wooden frame GenioFlex. The GenioFlex frame lightens the load on the joints connecting frame and legs and thus is perfectly apt for uneven floors, hugely extending the chair's lifespan. With a wide range of upholsteries, armrests and shell shapes to choose from, elena offers a tremendous diversity of options.

ELENA



1



2



3

-
- 1 Rücken 008 | ungepolstert
backrest 008 | without upholstery
 - 2 Rücken 008 | Sitzpolster
backrest 008 | seat upholstered
 - 3 Rücken 008 | Sitz- und Rückenpolster
backrest 008 | seat and backrest upholstered
 - 4 Rücken 017 | Sitzpolster
backrest 017 | seat upholstered
 - 5 Rücken 70 | Sitz- und Rückenpolster
backrest 70 | seat and backrest upholstered

AUSFÜHRUNG . DESIGN

Die Sitzmöbel sind in vielen verschiedenen Farben, Materialien und Veredelungen erhältlich. Für die Polsterung stehen zahlreiche Stoffe, Leder und Kunstleder zur Verfügung.

The seating furniture is available in various colors, materials and finishings. Several fabrics, leathers and artificial leathers can be chosen for upholstery.

ELENA



810-920 500-600 550-590 460-470 5,9-8,8 6-7

Gestell

elena 09: Rundstollen

elena 07: Vierkantstollen

Buche massiv

Lack | Beize gemäß Hauskollektion

verwindungsfähiger Schichtholz-

rahmen GenioFlex

Sitz und Rücken

Formholz

Holzfurnier | Lack | Beize

gemäß Hauskollektion

Zertifizierung

GS – Geprüfte Sicherheit | Quality Office

Preis

ab EUR 255,-



4



5

ARMLEHNEN . ARMRESTS

90



91



72



73

frame

elena 09: round profile

elena 07: square profile

solid beech

varnish | stains according to house collection

flexible laminated wooden frame GenioFlex

seat and backrest

plywood

wood veneer | varnish | stains

according to house collection

certification

GS – tested safety | Quality Office

Preis

from EUR 255,-

RÜCKEN . BACKRESTS

008 | H 810 mm



90 | H 820 mm



91 | H 870 mm



92 | H 920 mm



70 | H 820 mm



71 | H 870 mm



72 | H 920 mm



017 | H 820 mm



262



279



291



295



281

ELENA



BARHOCKER . BARSTOOL

Das Gestell des elena Barhockers besteht aus massivem Buchenholz, welches ihm besondere Stabilität verleiht. Verschiedene Beiztöne sowie ein optionales Sitzpolster ermöglichen Gestaltungsspielräume.

The frame of the elena barstool is crafted from massive beech wood and offers an extremely high degree of stability. Various staining colors in combination with an optional seat upholstery provide freedom of design.

ELENA



360

360

780

7,5-7,7



1



2

- 1 Ungepolstert · without upholstery
2 Sitzpolster · seat upholstered

Gestell

Vierkantstollen
Buche massiv
Lack | Beize gemäß Hauskollektion
Fußstütze Edelstahl

Sitz

Schichtholz
Lack | Beize | Holzfurnier
gemäß Hauskollektion

Preis

ab EUR 243,-

frame

square profile
solid beech
varnish | stains according to house collection
stainless steel footrest

seat

laminated wood
varnish | stains | wood veneer
according to house collection

price

from EUR 243,-



262



285



279



291



295



281

RONDO



1



2

-
- 1 rondo pure | Eiche, natur lackiert, mit Armlehnen, vollupolstert
oak, natural varnish, with armrests, fully upholstered
 - 2 rondo | Buche, natur lackiert
beech, natural varnish
 - 3 rondo | Buche, natur lackiert, mit Sitzpolster und Vorpulster,
mit Armlehnen
beech, natural varnish, with upholstered seat and fully upholstered
front, with armrests



3



RONDO

Der rondo Vierfußstuhl ist in den zwei Gestellvarianten rondo und rondo pure, mit und ohne Armlehnen sowie als Hochlehner erhältlich. Das Gestell besteht aus Buche-Massivholz in A-Qualität. Die Sitze und Rücken in neun querverleimten Furnierschichten sorgen für extreme Stabilität, Polstervarianten erhöhen den Sitzkomfort. Aufgrund dessen sind die rondo Stühle ideal für den Pflegebereich und für soziale Einrichtungen.

The rondo four-legged chair is available in two frame options, rondo or rondo pure, either with or without an armrest or optionally in the design of high back chair. The frame is made of massive beech wood in highest quality, seats and back rests consist of nine veneer layers and ensure extreme stability. Various choices of upholstery enhance the seating comfort and make rondo an ideal option for the care sector.

RONDO

rondo pure 192



rondo 190



-
- 1 Ungepolstert · without upholstery
 - 2 Sitzpolster · seat upholstered
 - 3 Sitzpolster, Rücken gepolstert · upholstered seat, backrest with fully upholstered front
 - 4 Vollpolster · fully upholstered
 - 5 mit Armlehnen · with armrests

AUSFÜHRUNG . DESIGN OPTIONS

Die Sitzmöbel sind in vielen verschiedenen Farben, Materialien und Veredelungen erhältlich. Für die Polsterung stehen zahlreiche Stoffe, Leder und Kunstleder zur Verfügung.

The seating furniture is available in various colors, materials and finishings. Several fabrics, leathers and artificial leathers can be chosen for upholstery.

RONDO



rondo pure	870	490 590	575	460	7-9,5	6-8
rondo	870	490 585	560	460	7-9,5	6-8



4



5



SCHWERLAST . HEAVY WEIGHT

rondo pure 192 Stuhl geprüft bis 150 kg von der Holzforschung Austria

rondo pure 192 chair tested for a user weight of up to 150 kg by Holzforschung Austria

rondo pure 192 Sessel geprüft bis 200 kg vom TÜV Austria

rondo pure 192 armchair tested for a user weight of up to 200 kg by TÜV Austria

Gestell

Buche massiv | Eiche massiv
Lack | Beize gemäß Hauskollektion

Sitz und Rücken

Formschichtholz
Holzfurnier | Lack | Beize
gemäß Hauskollektion

Zertifizierung

rondo 190: GS – Geprüfte Sicherheit
rondo pure 192 Schwerlaststuhl: ÖNORM

Preis

ab EUR 178,-

frame

solid beech | solid oak
varnish | stains according to house collection

seat and back rest

molded plywood
wood veneer | varnish | stains
according to house collection

certification

rondo 190: GS – tested safety
rondo 192 heavy weight chair: ÖNORM

price

from EUR 178,-



262



279



291



295



281

RONDO



1

HOCHLEHNER . HIGH-BACK CHAIR

Sicherheit und Komfort bietet der rondo Hochlehnsessel. Dank des stabilen Gestells aus massivem Buchenholz und der hohen Rückenlehne eignet sich der Sessel besonders für den Einsatz in Pflege- und sozialen Einrichtungen. Die Armlehnen bieten Unterstützung beim Aufstehen und Hinsetzen; ein optionales Nackenpolster entlastet und unterstützt den Halswirbelbereich. Der Hochlehner ist in den Varianten rondo und rondo pure erhältlich.

The rondo high-back chair is a synonym for safety and comfort. Due to the stable frame made of solid wood and to the high backrest the high-back chair is suitable for care and social institutions. The armrests provide support when standing up and sitting down. Optional headrests relieve neck and cervical-spine. The high-back chair is available in two variants, rondo and rondo pure.

RONDO



rondo	1010	585	670	460	9,8	6
rondo pure	990	590	660	460	10,5	8



2



3

Gestell

Buche massiv | Eiche massiv

Sitz und Rücken

Formschichtholz

Furnier | Lack | Beize
gemäß Hauskollektion**Optionen**

Gestell auch als rondo pure erhältlich

Preis

ab EUR 249,-

frame

solid beech | solid oak

seat and back restmolded plywood
veneer | varnish | stains
according to house collection**design options**

frame available as rondo pure

price

from EUR 249,-

-
- 1 rondo pure | Hochlehner · high-back chair
 2 rondo | Hochlehner · high-back chair
 3 rondo | Hochlehner mit Nackenpolster · high-back chair with headrest



262



279



291



295



281

RONDO



1

SESSEL . ARMCHAIR

Komfortables Sitzen verspricht der verstellbare Sessel aus der rondo Serie. Das Gestell aus Massivholz verleiht dem Sitzmöbel festen Stand, die Nackenlehne – ob fest oder höhenverstellbar – entlastet den Halswirbelbereich. Optional kann der Sessel mit mechanisch verstellbarem Sitz und Rücken sowie mit ausziehbarem Fußteil geliefert werden.

The adjustable rondo armchair promises comfortable seating. The frame made of solid wood provides safe stand, the fixed or height-adjustable headrest relieves neck and cervical-spine. Optionally, the rondo armchair can be equipped with mechanically adjustable seat and backrest as well as with an extendable footrest.

RONDO

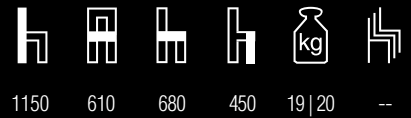

1150 610 680 450 19|20 --



2

3

Gestell

Buche massiv
Beize | Lack gemäß Hauskollektion

Sitz und Rücken

Formschichtholz

Optionen

Sitz und Rückenlehne mechanisch verstellbar
Nackensstütze, fest oder höhenverstellbar
Fußteil ausziehbar

Zertifizierung

ÖNORM

Preis

ab EUR 849,-

- 1 rondo 283 | feste Nackensstütze, verstellbare Rückenlehne ·
fixed headrest, adjustable backrest
- 2 rondo 285 | feste Nackensstütze, verstellbarer Sitz und Rücken,
ausziehbares Fußteil · fixed headrest, adjustable seat and back
rest, extendable footrest
- 3 rondo 285 | höhenverstellbare Nackensstütze, verstellbarer Sitz
und Rücken, ausziehbares Fußteil · height-adjustable headrest,
adjustable seat and backrest, extendable footrest

frame

solid beech
varnish | stains according to house collection

seat and back

molded laminated plywood

design options

seat and back rest mechanically adjustable
headrest fixed | optional: adjustable in height
extendable foot rest

certification

ÖNORM

price

from EUR 849,-

SCHWERLAST . HEAVY WEIGHT

rondo Sessel 283 geprüft bis 200 kg von der Holzforschung
Austria

rondo armchair 283 tested for a user weight of up to 200 kg by
Holzforschung Austria



262

279

291

295

281

RONDO



BANK . BENCH

Ganz gleich, ob Ein-, Zwei- oder Drei-Sitzer: Die rondo Polsterbank bietet in jedem Fall hohen Sitzkomfort und Stabilität. Diese entsteht durch das Gestell aus massivem Holz. Zwei Gestellvarianten, rondo und rondo pure, stehen bei der rondo Polsterbank zur Auswahl.

No matter if one-, two-, or three-seater, rondo's upholstered bench offers comfort in seating and stability thanks to its massive wooden frame. The bench is available in two frame variants, rondo and rondo pure.

RONDO



1000 670-1710 620 430 15-35 6



1



2



3

Gestell

Buche massiv
Beize | Lack gemäß Hauskollektion

Optionen

Gestell auch als rondo pure erhältlich

Preis

ab EUR 687,-

frame

solid beech
stains | varnish according to house collection

design options

frame available as rondo pure

price

from EUR 687,-

- 1 1-Sitzer · one-seater
2 2-Sitzer · two-seater
3 3-Sitzer · three-seater



262



279



291



295



281

RONDO



LOUNGEMÖBEL . LOUNGE FURNITURE

Seniorengerechtes Sitzen verspricht die rondo Polsterserie mit einem Gestell aus robustem Massivholz. Die Sitze sind fest gepolstert und stabil mit dem Sitzrahmen verschraubt. Auf Wunsch können die Wohnmöbel mit abnehmbaren Sitzbezügen, optional mit Nässeschutzfolie, ausgestattet werden.

Senior-friendly seating is offered by the rondo collection with its fauteuil resting on a massive wooden frame. The seat is firmly upholstered and tightly screwed to the frame. Removable covers and an optionally addable moisture protection can be ordered upon request.

RONDO



1



2



3



835 670 | 1220 | 805 440 20 | 38 | 56 --
1770

Gestell

Buche massiv

Sperrholz

Lack | Beize gemäß Hauskollektion

Polsterung

Sitz fest gepolstert

mit Sitzrahmen verschraubt

Rückenkissen lose

Preis

ab EUR 917,-

frame

solid beech

plywood

varnish | stains according to house collection

upholstery

seat fix upholstered

screwed to the frame

loose back cushions

price

from EUR 917,-

1 Polstersessel · lounge chair

2 2-Sitzer · two-seater

3 3-Sitzer · three-seater



262



279



291



295



281

li-lith

design
gregor
eichinger

architekt gregor eichinger entwarf li-lith ursprünglich für die gehobene wiener gastronomie. charakteristische merkmale des holzstuhls sind seine leichtigkeit und die geschwungene armlehne, welche in verbindung mit der breiteren sitzfläche der aufbewahrung persönlicher gegenstände dient. li-lith kann in vielen farben und holzarten gestaltet werden und lässt sich an bestehende raumkonzepte anpassen.

gregor eichinger's concept of li-lith was originally created for vienna's exclusive gastronomy sector. its characteristic features include its lightness and curved armrest, which ensures a secure storage of handbags and other personal belongings in combination with the broader seat surface. li-lith offers a wide range of choices in colors as well as wood types and suits various architectural concepts perfectly.

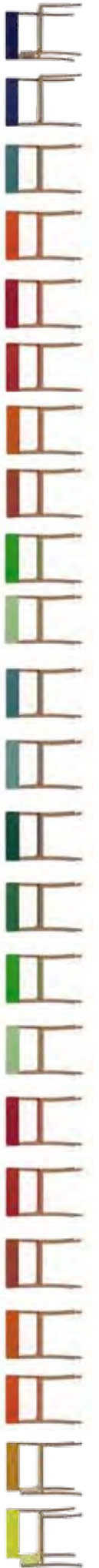

reddot award 2015
honourable mention

li-lith

sessel armchair



295



291



279





1



2



3



1 ungepolstert · not upholstered

2 sitzpolster · upholstered seat

3 sitz- & rückenpolster · upholstered seat and backrest

maße

h 830 x b 570 x t 530 mm

gestell

massive eiche | massive buche

sitz & rücken

formschichtholz

innen und außen messerfurnier

ausführung

lack | beize gemäß hauskollektion

optional: bezug mit stoff | leder gemäß hauskollektion

armlehnen

massive eiche | massive buche

wahlweise mit 1 armlehne links | rechts oder mit 2 armlehnen

zertifizierung

ÖNORM

preis

ab eur 401,-

dimensions

h 830 x w 570 x d 530 mm

frame

solid oak | solid beech

seat & back

plywood

sliced veneer inside and outside

design

varnish | stains

according to house collection

optional: fabric cover | leather cover

according to house collection

arm rests

solid oak | solid beech

optional with 1 arm rest left/right

or with 2 arm rests

certification

ÖNORM

price

from eur 401,-

li-lith

barhocker barstool



295



291



279



der li-lith barhocker besticht durch seine einzigartig geformte lehne, die gleichzeitig tragegriff ist. das gestell aus massivholz verleiht dem barhocker die notwendige stabilität. das für den fußring verwendete holz wurde mithilfe der traditionellen bugholztechnik in handarbeit gebogen. für optimalen sitzkomfort ist die runde sitzfläche wahlweise mit stoff oder leder bezogen.

the li-lith barstool impresses with its uniquely shaped backrest, which also serves as carrying. the solid wooden frame provides stability. the wooden foot handle rest is handmade using the traditional bentwood technique. for optimal seating comfort the round seat is optionally covered with fabric or leather.



1



2

maße

h 920 x b 420 x t 420 mm

gestell

massive eiche | buche

sitz

formschichtholz

ausführung

lack | beize gemäß hauskollektion
optional: bezug mit stoff | leder gemäß
hauskollektion

fußring

bugholz aus massiver eiche | buche
wahlweise mit metallschutz

preis

ab eur 544,-

dimensions

h 920 x w 420 x d 420 mm

frame

solid oak | beech

seat

plywood

design

varnish | stains
according to house collection
optional: fabric cover | leather cover
according to house collection

foot rest

bentwood made of solid oak | solid
beech
optional metal cover

price

from eur 544,-

1 eiche natur lackiert · natural varnished oak

2 buche schwarz gebeizt · black stained beech

li-lith

b e n c h
b e n c h



295



291



279



ein gestell aus massivem holz ist basis für die von gregor eichinger entworfene li-lith bank. sie ist mit offenem oder geschlossenem rückenteil erhältlich. die holzbank ist mit einem sitzpolster ausgestattet, für erhöhten komfort kann auch der rücken gepolstert werden.

a solid wooden frame is the basis for the li-lith bench designed by gregor eichinger. It is available with an open or closed backrest. The wooden bench is equipped with an upholstered seat, for increased comfort the backrest can also be padded.

**maße**

h 830 x b 1380 x t 530 mm

gestell

massive eiche | massive buche

sitz & rücken

formschichtholz

innen und außen messerfurnier

optional mit durchgehender rückwand

ausführung

lack | beize gemäß hauskollektion

optional: bezug mit stoff | leder

gemäß hauskollektion

armlehnen

massive eiche | massive buche

2 armlehnen

preis

ab eur 1.002,-

**dimensions**

h 830 x w 1380 x d 530 mm

frame

solid oak | solid beech

seat & back

plywood

sliced veneer inside and outside

optional: continuous back panel

design

varnish | stains

according to house collection

optional: fabric cover | leather cover

according to house collection

arm rests

solid oak | solid beech

2 arm rests

price

from eur 1.002,-

bank mit offenem rückenteil | eiche natur lackiert | sitz und rücken gepolstert
bench with open backrest | natural varnished oak | seat and back upholstered

g e i c h i n g e r



gregor eichinger zählt zu den renommiertesten architekten und designern österreichs. mit seinen raumkonzepten (lugeck, ansari, song u. a.) sorgt er von wien aus international für furore. eichingers arbeiten ist die wiener design- und kulturgeschichte inhärent, zugleich geben seine entwürfe sich offen gegenüber aktuellen phänomenen. mit seinem interesse für oberflächen und codes macht gregor eichinger lokal-spezifisches international lesbar und prägt so einen neuen wiener stil, der sich als gegenwärtig, jedoch nicht zeitgeistig beschreiben lässt. emotion als baustoff denkend versucht gregor eichinger mit seinem team, jeden seiner entwürfe sinnlich erfahrbar zu machen. gregor eichinger lehrt an universitäten im in- und ausland.

gregor eichinger is one of austria's best-known architects and designers. the spatial concepts (lugeck, ansari, song, etc.) he creates in vienna are an international sensation. eichinger's work is steeped in the design and cultural history of vienna; at the same time, his designs are open to modern phenomena. with his interest in surfaces and codes, gregor eichinger makes the specifically local internationally understandable, thereby creating a new viennese style that is up-to-date but not in thrall to the zeitgeist. he teaches at universities in austria and abroad.

g
m

o
g

e

r
r



li-lith - edition roland rainer

**ARCHITECTURE IS
NOTHING BUT A
KIND
OF APPLIED
PHYSIOLOGY**



© Delugan Meissl Industrial Design

**DELUGAN MEISSL
INDUSTRIAL DESIGN**

TENDO





1

-
- 1 Eiche massiv | mit Armlehnen | ungepolstert
solid oak | with armrests | not upholstered
 - 2 Schwarz matt decklackiert | mit Armlehnen | ungepolstert
black matte varnished | with armrests | not upholstered

TENDO

Der Holzstuhl, mit dem die Wiener Designer von Delugan Meissl Industrial Design konstruktive Leichtigkeit und Funktionalität auf ausgewogene Weise miteinander verbinden, heißt tendo. Die filigrane Holzkonstruktion verschmilzt mit der Tragestruktur aus Metall und verbindet so feingliedrige Eleganz mit Stabilität. Material und Form verbinden sich zu einem stapelbaren Schalenstuhl.

tendo is the name of the wooden chair that interconnects a lightweight construction with functionality in a well-balanced manner. It is designed by the Viennese architects Delugan Meissl Industrial Design. The filigree wooden construction blends into the supporting structure made of stainless steel and thus combines refined elegance with solidity. Material and shape combine to a shell chair with high seating comfort and easy handling.

Gestell

Buche massiv | Eiche massiv
Lack | Beize gemäß Hauskollektion
Vorder- und Hinterfüße verstärkt mit Metallsehne
Sitzrahmen aus Edelstahl

Schale

Formschichtholz
Lack | Beize gemäß Hauskollektion

frame

solid beech | solid oak
varnish | stains according to house collection
front and rear legs strengthened with metal tendon
stainless steel seat frame

shell

laminated wood
varnish | stains according to house collection



DELUGAN MEISSL INDUSTRIAL DESIGN

Das international renommierte Architekturbüro Delugan Meissl Associated Architects hat im Entwurfsprozess den Anspruch, die räumliche Erfahrbarkeit durch den künftigen Nutzer zu thematisieren und sich gleichzeitig am bestehenden Gefüge zu orientieren. Ein Beispiel dafür ist der Entwurf des Festspielhauses Erl mit seiner scharfkantigen Geometrie. Zu anderen international bekannten Projekten zählen auch das EYE Filminstitut in Amsterdam oder das Porsche Museum in Stuttgart. Kooperationen mit namhaften Herstellern waren 2012 Anlass für die Gründung der Marke DMID, Delugan Meissl Industrial Design. Die damit einhergehende Erweiterung des eigenen Aufgabenspektrums führte zur Entwicklung erfolgreicher Produkte abseits der ursprünglichen Kernkompetenz. Die Architekten Elke Delugan-Meissl und Roman Delugan erhielten 2015 den Großen Österreichischen Staatspreis, die höchste künstlerische Auszeichnung der Republik.

In the process of design, the internationally renowned architectural office Delugan Meissl Associated Architects always seeks to make the spatial experiences of the future user a subject of discussion and to orientate on existing structures. The design of the Festspielhaus Erl with its sharp-edged geometry is only one example. Other international projects are the EYE film institute in Amsterdam or the Porsche Museum in Stuttgart. Cooperations with reputable manufacturers in 2012 gave rise for the establishment of the brand DMID, Delugan Meissl Industrial Design. The expansion of the task spectrum lead to the development of successful products apart from the original core competences. In 2015, the architects Elke Delugan-Meissl and Roman Delugan were awarded with the Grand Austrian State Prize, the highest official Austrian award.

**DELUGAN MEISSL
INDUSTRIAL DESIGN**

TENDO



295



291



279



Stuhl ohne Armlehnen
ungepolstert | mit Vorpulster
Preis: ab EUR 627, -
chair without armrests
not upholstered | fully upholstered front
price: from EUR 627, -

Stuhl mit Armlehnen
ungepolstert | mit Vorpulster
Preis: ab EUR 679, -
chair with armrests
not upholstered | fully upholstered front
price: from EUR 679, -

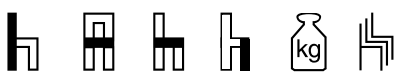

840 455 575 465 7,7-8,2 4

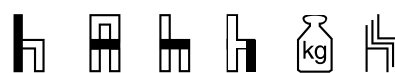

840 525 575 465 8,3-8,8 4

KOLLEKTION · 58

KARL SCHWANZER



FAUTEUIL
 OUTDOOR
 FAUTEUIL
 SIDE
 TABLE
 CONTRACT
 CHAIR
 CONTRACT
 TABLE

Die Kollektion.58 des österreichischen Architekten und Möbeldesigners Karl Schwanzer – bestehend aus Fauteuil, Outdoor Fauteuil, Side Table, Contract Chair und Contract Table, Barhocker und Stehtisch – zeichnet sich durch ihre konische Linien- und Konturenführung aus. Die Möbel der Karl Schwanzer Kollektion bedienen sich exklusiver Materialien: hochwertige Stoffe und Leder, Massivholz, Furnier und Chrom. Karl Schwanzer, Architekt des als 21er Haus bekannt gewordenen österreichischen Pavillons zur Weltausstellung 1958 in Brüssel, entwarf den markanten Fauteuil eigens für das 21er Haus.

"Kollektion.58" by the Austrian architect and furniture designer Karl Schwanzer comprises armchair, wooden chair, side table, contract chair and contract table, bar stool and stand-up table. Tapered lines and contours provide the characteristic heart of these design classics. The furniture pieces in the Karl Schwanzer collection are made with exclusive materials: premium fabrics and leathers, solid wood, veneer and chrome. Karl Schwanzer, the architect of the Austrian pavilion at the 1958 Brussels World's Fair, now known as "21er Haus", designed the striking armchair specially for this building.

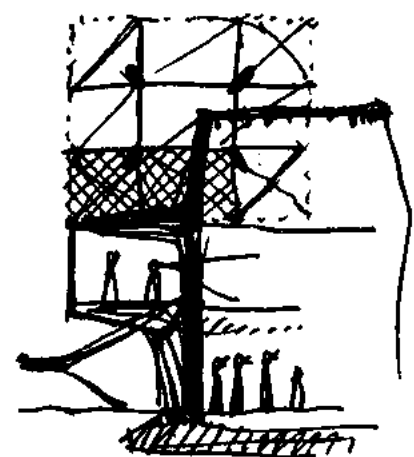
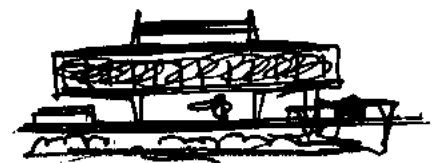

KOLLEKTION 58

KARL SCHWANZER

FAUTEUIL
OUTDOOR
FAUTEUIL
SIDE
TABLE



295



291



285



279



815 710 730 430 24,5

FAUTEUIL

Gestell: Holzteile massiv
Unterkonstruktion: Buche massiv/Sperrholz,
Unterpolsterung mit Gurtbespannung
Seitenteile: Flachstahl, verchromt | Schwarzchrom
Armauflage: Massivholz Buche | Eiche | Walnuss

frame: solid wooden parts
supporting construction: solid beech/plywood,
base upholstery with belt support
side parts: flat steel, chrome-plated | black
chrome
armrest panels: solid wood beech | oak | walnut

Preis ab EUR 1.307,-
price from EUR 1.307,-



815 690 730 390 24

OUTDOOR FAUTEUIL

Lattenrost: massives Akazienholz, geölt
Gestell: Metall, polyamidbeschichtet, braun

slatted frame: solid acacia, oiled
frame: polyamide-coated metal, brown

Preis ab EUR 1.049,-
price from EUR 1.049,-



475 1600 600

SIDE TABLE

Tischplatte: Spanplatte, Kantenprofil Holz
Tischfüße: Formrohr
Glasplatte: Einscheiben-Sicherheitsglas mit
polierten Kanten
Maß Glasplatte: 920 x 600 mm

table top: chipboard, wooden edge profile
legs: shaped tube
glass plate: toughened safety glass with pol-
ished edges
dimensions glass plate: 920 x 600 mm

Preis ab EUR 1.418,-
price from EUR 1.418,-

KOLLEKTION 58

KARL SCHWANZER

CONTRACT CHAIR & CONTRACT TABLE



295



291



279



     
855 490 420 455 7,5 6

CONTRACT CHAIR

Vorderfüße: Buche massiv | Ahorn massiv

Hinterfüße: Bugholz massiv

Rahmen: fingerverzinkt, Holzverbindung mit Verleimfräsung und zusätzlichen Massivholz-Eckverbindern

Sitz und Rücken: Formschichtholz, natur lackiert, Beiztöne gegen Aufpreis

front legs: solid beech | solid maple

rear legs: solid bentwood

frame: finger-jointed, wood connection with glued milling and additional solid wood corner connectors

seat and backrest: molded laminated plywood, natural varnish, stains at additional charge

Preis ab EUR 449,-

price from EUR 449,-



  
740 600-1600 600-800

CONTRACT TABLE

Gestell: Buche massiv | Eiche massiv | Ahorn massiv

Tischplatte: Spanplatte 19 mm

Tischplatte auf Gehrung in das Gestell eingeleimt

Oberflächen: Holzfurnier | Beize | Lack | HPL gemäß Hauskollektion

frame: solid beech | solid oak | solid maple

table top: chipboard 19 mm

table top glued with a mitre into the frame

surfaces: wood veneer | stains | varnish | HPL according to house collection

Preis ab EUR 712,-

price from EUR 712,-

KOLLEKTION · 58

KARL SCHWANZER

KARL SCHWANZER

Karl Schwanzer [1918-1975], bedeutender Vertreter der Nachkriegsarchitektur, gründete nach seinem Architekturstudium an der TH Wien sein eigenes Atelier. Die internationale Anerkennung ließ zunächst auf sich warten, basierte schließlich auf Schwanzers Arbeitsweise und seiner Einstellung zur Architektur, entsprechend dem Leitgedanken „Qualität geht vor Verdienst“. Mit dieser Maxime prüfte er selbst bei kleinsten Aufgaben die Einhaltung des von ihm geforderten qualitativen Niveaus. Schwanzer beschritt neue Wege in der Architektur und entwickelte eine Vielzahl prägnanter Bauwerke, darunter den als Vierzylinder bekannten BMW-Hauptsitz in München. Zudem war er Möbeldesigner und Gründer des Österreichischen Instituts für Formgebung.

Karl Schwanzer [1918-1975], a key proponent of post-war architecture, founded his own studio on graduating from Vienna's University of Technology. International recognition did not come immediately, ultimately a consequence of Schwanzer's working methods and his attitude towards architecture, guided by the principle that "quality is more important than merit". Firmly convinced of this, he was meticulous in adhering to his own quality standards, no matter how small the assignment. Schwanzer pioneered new techniques in architecture and designed many striking structures, including the BMW headquarters in Munich, also known as the "BMW four-cylinder". He was also a furniture designer and founded the Austrian Institute for Design.



A R C H I
T E K T U R
I S T
M A T E R I A
L I S I E R T E
P O E S I E

Karl Schwazer

architecture is materialized poetry

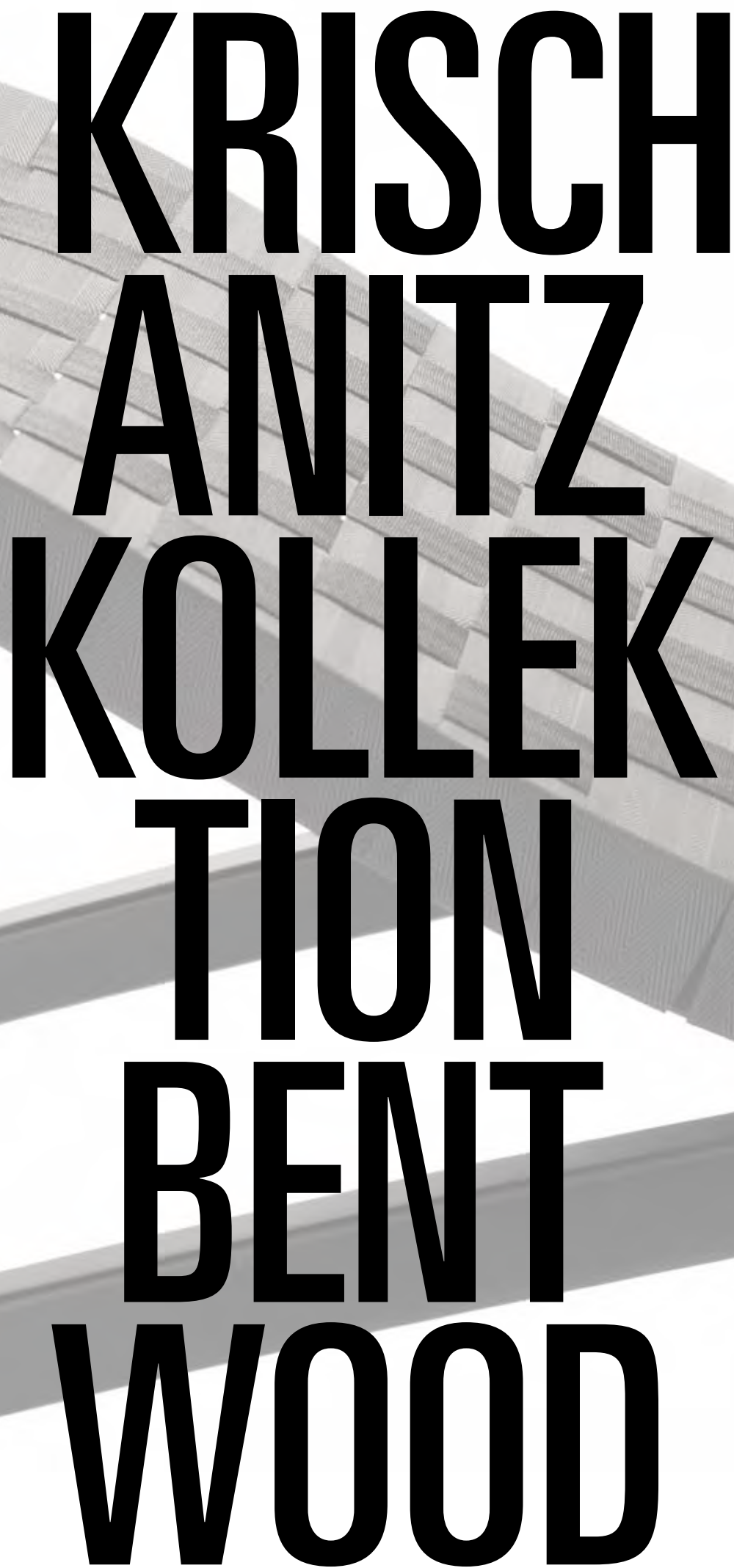

**KRISCH
ANITZ
KOLLEK
TION
BENT
WOOD**



COLLECTION **BENTWOOD**

Die Krischanitz Kollektion bentwood nutzt Bugholz nicht nur als leichtes und auf das Wesentliche reduziertes Basismaterial, sondern auch als gestalterisches Mittel, um vier Möbel mit markanten Wesenszügen und jeweils spezifischen Gebrauchs- und Bedeutungsformen herauszuarbeiten.

The Krischanitz collection uses bentwood not just as a light base material reduced to the purely essential, but also as a means of design for devising four furniture pieces with striking traits and separate uses and referents.

D

E

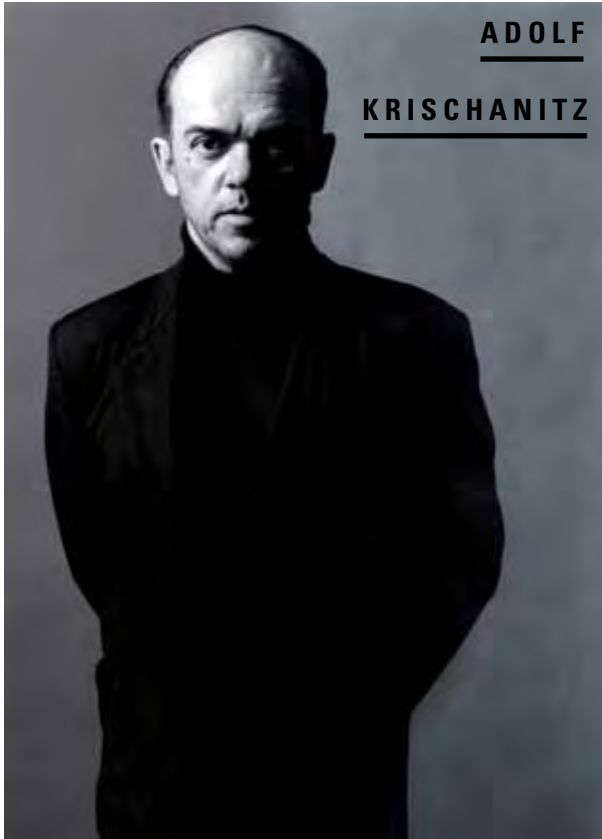

ADOLF
KRISCHANITZ

Photography © Matthias Hermann

International tätiger Architekt mit Büros in Wien und Zürich, realisierte zahlreiche Bauten für Kunst und Kultur. Neben dem 21er Haus und der Kunsthalle Karlsplatz in Wien gehören Wohn-, Bildungs- und Industriebauten wie beispielsweise der Novartis Campus, Basel, zu seinen Werken. Im Oktober 2012 gewann er den Projektwettbewerb für den Umbau des Konzern Hauptsitzes der Zurich Insurance Company Ltd. Er hat eine Professur für "Stadterneuerung und Entwerfen" an der Universität der Künste in Berlin.

Adolf Krischanitz, an international architect with practices in Vienna and Zürich, has designed many structures for the arts and cultural life. Alongside the "21er Haus" and the Kunsthalle Karlsplatz in Vienna, his works include residential, educational and industrial buildings, such as the Novartis Campus in Basel. In October 2012, he won the project competition to convert the group headquarters of Zurich Insurance Company Ltd. Krischanitz has participated in the Venice international architecture exhibition on several occasions and holds a professorship in urban renewal and design at the Berlin University of the Arts.

I

G

S



bentwood co01 | contract chair

Gestell Bugholz Buche massiv
Sitzschale aus Formschichtholz
ungepolstert | Vorpolster

frame bentwood made of solid beech
shell made of plywood
not upholstered | fully upholstered front



830 545 620 455 8 Preis ab EUR 336,-
price from EUR 336,-



bentwood co02 | armchair

Gestell Bugholz Buche massiv
Sitzschale aus Formschichtholz
Vollpolster

frame bentwood made of solid beech
shell made of plywood
fully upholstered

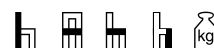

770 580 620 460 10 Preis ab EUR 368,-
price from EUR 368,-

N

K



295



291



279



O

bentwood co03 | chairbed

Bugholz, Buche decklackiert
Unterpolsterung Gurtbespannung
Rahmen für Gurtbespannung ist
schichtverleimt
Liegefläche seitlich verleimt
optional mit Nackenkissen

bentwood, varnished beech
belt base upholstery with belt support
frame for belt support is glued in layers
reclining surface laterally glued
optional headrest



Preis ab EUR 2.048,-
price from EUR 2.048,-

775

530

1650

250-450

13

bentwood co04 | daybed

Bugholz, Buche decklackiert
Unterpolsterung Gurtbespannung
Rahmen für Gurtbespannung ist
schichtverleimt
optional: abnehmbare Polsterauflage,
optional mit Nackenkissen

bentwood, varnished beech
base upholstery with belt support
frame for belt support is glued in layers
optional removable padding with
optional headrest



Preis ab EUR 2.048,-
price from EUR 2.048,-

445

650

1950

385

20

L



L E K T I O N

core

design: andreas calließ





295



279

DIE AUS EINEM EINZIGEN, ÜBER
100 JAHRE ALTEN EICHENSTAMM
GEFERTIGTE BANK WIRKT DURCH
IHRE MINIMALISTISCHE FORMEN-
SPRACHE. DIE TRADITIONELLE
HANDWERKSKUNST
DER SCHWALBENSCHWANZVERZIN-
KUNG GARANTIERT EIN HÖCHST-
MASS AN ÄSTHETIK & WERTIGKEIT.

the core reclining bench seat, crafted from a single tree trunk over 100 years old, really captivates with its minimalist style. the traditional craft technique of dovetail jointing guarantees the highest degree of aesthetics and quality.





Maße Bank: H 440 mm | B 2000 mm | T 450 mm

Material Bank: Eiche, massiv, Oberfläche geölt | gearbeitet aus einem Stück | Schwalbenschwanzverzinkung

optionales Rückenelement: verschiebbar, schwenkbar
Polsterstärke: 60 mm

Maße Rückenelement: H 1000 mm | B 500 mm | T 60 mm

Höhe mit Rückenelement: 1120 mm

ab EUR 2.860,-

dimensions bench: h 440 mm | w 2000 mm | d 450 mm

material bench: solid oak, oiled surface | made of one single trunk | dovetail joint

optional back rest: moveable, pivotable
upholstery thickness: 60 mm

dimensions backrest: h 1000 mm | w 500 mm | d 60 mm

height with backrest: 1120 mm

from EUR 2.860,-

ULTIMO

Design: Kim Kim Design



MIT IHREM MODERNEN DESIGN, DEM HOHEN SITZKOMFORT UND DEM ATTRAKTIVEN PREIS-LEISTUNGS-VERHÄLTNIS GEHÖRT DIE ULTIMO POLSTERSERIE ZU DEN ULTIMATIVEN LOUNGEMÖBELN. OB LOBBYS, GESCHÄFTS- ODER WARTERÄUME – DANK DER GROSSEN AUSWAHL AN BEZUGSMATERIALIEN UND FUSS-VARIANTEN KÖNNEN DIE BEQUEMEN ULTIMO POLSTERMÖBEL PERFEKT IN NAHEZU JEDE RAUMSITUATION INTEGRIERT WERDEN. OPTIONALE RÜCKENKISSEN VERRINGERN DIE SITZTIEFE.

With its modern design, great seating comfort and very attractive pricing, the ultimo product range represents the ultimate in lounge furniture. Whether it's intended for lobbies, reception or waiting areas – the comfortably upholstered furniture items can be integrated in virtually all room scenarios thanks to its huge range of cover materials and leg designs. Optional back cushions reduce the seat depth and enhance seating comfort.

ULTIMO

TECHNISCHE DATEN

TECHNICAL DETAILS



DE ultimo mit Drehkreuz-Fußvariante - die elegante Wahl für ansprechende Loungezonen

EN ultimo with cross foot - an elegant choice for attractive lounge areas

ULTIMO



Tisch
table



450 700 700

Clubsessel
lounge chair

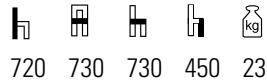

720 730 730 450 23

2-Sitzer
2-seater

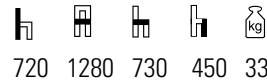

720 1280 730 450 33

3-Sitzer
3-seater

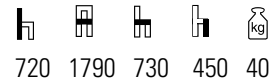

720 1790 730 450 40

AUSFÜHRUNG | FINISHING

Gestell	Hartholz
Polsterung	Stahlwellenfedern hochwertiger Polyätherschaum
Gleiter	Polyamidgleiter braun
Bezug	Stoffklasse 1 - 7 Hinweis Leder: zusätzliche Nähte sichtbar
Zubehör	Kissen in allen Stoffklassen
Tisch	Korpus in Stoff Leder Kunstleder gepolstert Tischplatte HPL gemäß Hauskollektion Kante 030
Preis	ab EUR 693,-

frame	hard wood
upholstery	steel wave springs high-quality polyether foam
glider	polyamide glider, brown
cover	fabric class 1 - 7 Note: additional visible seams on leather cover
accessories	cushions in all fabric classes
table	body upholstered in fabric leather artificial leather table top with HPL cover according to house collection, edge 030
price	from EUR 693,-



295 291 285 279

ULTIMO

FUSSVARIANTEN

FOOT VARIANTS

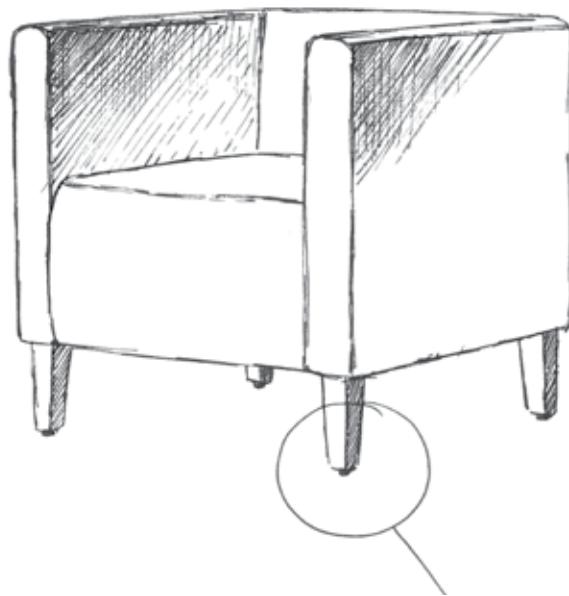

Buche natur,
Beize gemäß Hauskollektion
beech, natural varnish, stains
according to house collection



Eiche natur,
Beize gemäß Hauskollektion
oak, natural varnish, stains
according to house collection



Kreuzgestell,
verchromt | drehbar
cross foot
chrome-plated | rotatable



Rundrohr,
verchromt
round tube,
chrome-plated



Kufengestell,
verchromt
skid-base frame,
chrome-plated



Quadratrohr-
untergestell, verchromt
square tube frame,
chrome-plated

ULTIMO

ERGÄNZENDE ELEMENTE

ADDITIONAL ELEMENTS

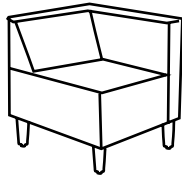

1

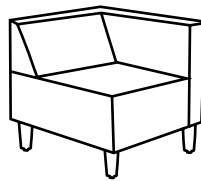

2

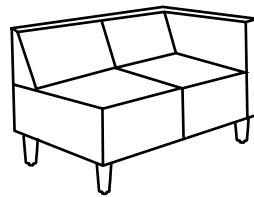

3

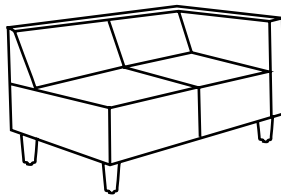

4

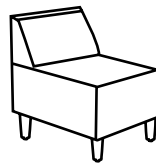

5

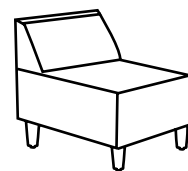

6

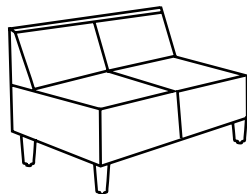

7

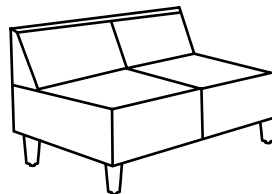

8

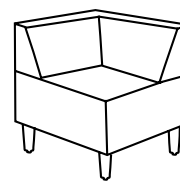

9

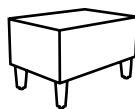

10

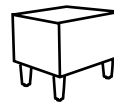

11

- 1 Element mit Armlehne links oder rechts
- 2 Element mit Armlehne links oder rechts
- 3 2er-Bank mit Armlehne links oder rechts
- 4 3er-Bank mit Armlehne links oder rechts
- 5 Element klein ohne Armlehne
- 6 Element groß ohne Armlehne
- 7 2er-Bank ohne Armlehne
- 8 3er-Bank ohne Armlehne
- 9 Eckelement
- 10 Anbauhocker
- 11 Beistellhocker

- 1 element with left or right armrest
- 2 element with left or right armrest
- 3 2-seater with left or right armrest
- 4 3-seater with left or right armrest
- 5 small element without armrest
- 6 large element without armrest
- 7 2-seater without armrest
- 8 3-seater without armrest
- 9 corner element
- 10 additional stool
- 11 side stool

WIENER FAUTEUIL

[Design: BEHF Corporate Architects]



Die Kollektion Wiener Fauteuil, bestehend aus Fauteuil, Barhocker und Tisch, wurde von den Architekten des Wiener Büros BEHF kreiert. Komfort und Gemütlichkeit schaffen die Polsterfauteuils mit abgesetzten Kedern und Füßen aus Massivholz. Sie erinnern an das Design der 1950er Jahre. Eine Wellenfederung mit Schaumstoffaufbau sorgt für außergewöhnlichen Sitzkomfort. Der passende Tisch ist die ideale Ergänzung. Eine sichtbare Miniverzinkung ist beim Barhocker zu erkennen, dessen Polster ebenfalls mit abgesetzten Kedern versehen ist.

The Wiener Fauteuil collection consisting of a Fauteuil, a barstool and a table has been developed by the architects of BEHF, a Vienna based architectural firm. With their nuanced piping and massive wooden legs the upholstered fauteuils create comfort and a cozy atmosphere in remembrance of the design of the 1950s. A springing with a multi-layered foam construction guarantees seating comfort. The collections matching table is the perfect addition. Visible dovetailed joints are found in the bar stool, whose comfortable upholstery also features nuanced piping.



WIENER FAUTEUIL



295



291



285



279

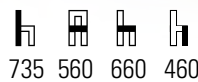

ab from
EUR 872,-

WIENER FAUTEUIL

Füße aus Buche massiv | Eiche massiv | Kirsche massiv |
Walnuss massiv

Beize | Lack gemäß Hauskollektion

Unterkonstruktion aus Buche massiv und Sperrholz

Unterpolsterung mit Wellenfedern

feet made of solid beech | solid oak | solid cherry | solid walnut
varnish | stains according to house collection
under construction made of solid beech and plywood
base upholstery with wave springs



ab from
EUR 882,-

TISCH | TABLE

Buche massiv | Eiche massiv | Kirsche massiv |
Walnuss massiv

Beize | Lack gemäß Hauskollektion

Tischplatte furniert Buche | Eiche | Kirsche | Walnuss

Bodenplatte schwarz polyamidbeschichtet

solid beech | solid oak | solid cherry | solid walnut
varnish | stains according to house collection
table-top wood veneer beech | oak | cherry | walnut
base plate black polyamide-coated



ab from
EUR 819,-

BARHOCKER | BARSTOOL

Buche massiv | Eiche massiv | Kirsche massiv |
Walnuss massiv

Beize | Lack gemäß Hauskollektion

solid beech | solid oak | solid cherry | solid walnut
varnish | stains according to house collection

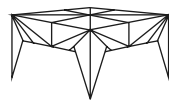
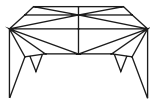
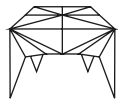

TISCHE

TABLES

DELTA 110



-
- 1 Tischplatte belegt mit Holzfurnier | Gestell verchromt
table top with wood veneer | chrome-plated frame



1

DELTA 110

Der außerordentliche Variantenreichtum der Klapp-tische delta 110 sowie das schlichte einsäulige Gestell bieten eine Vielzahl individueller Gestaltungsmöglichkeiten. Die praktische Handhabung durch den verbesserten delta Klappbeschlag 100.1 und die Tischfuß-Ausfallsicherung erleichtern den Auf- und Abbau der klappbaren Tische der delta Kollektion.

The extraordinary assortment of colors and styles in the folding table line delta 110 with its modern single-leg frame and its clean lines provides a wide range of customized design options. Practical handling with the patented and advanced hinge mechanism delta 100.1, which also protects the table legs from slipping, make it a simple matter to set up and put away the delta 110 tables.

DELTA 110

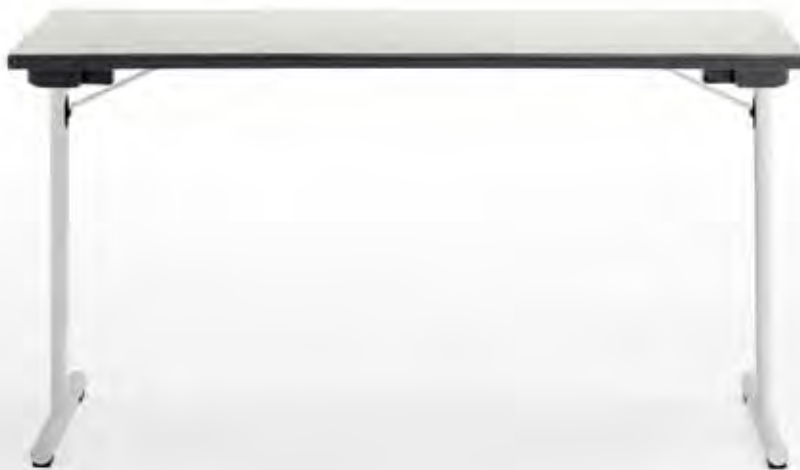

Weißer Tischplatte mit schwarzer Kante | Gestell weiß
polyamidbeschichtet · white table top with black edge |
frame polyamide-coated in white

AUSFÜHRUNG . DESIGN

Verschiedene Tischformen, Tischgrößen und Plattenmaterialien, umfangreiches Zubehör sowie eine große Auswahl an Farben und Dekoren ermöglichen die Anpassung an individuelle Raumkonzepte.

Various shapes and sizes of tables, board materials, accessories as well as a large variety of colors and decors allow the adjustment to individual room designs.

DELTA 110**Tischhöhe**

740 - 750 mm

Gestell

Rundstahlrohr, Flachovalrohr
verchromt | polyamidbeschichtet
gemäß Hauskollektion

Tischplatte

Spanplatte | Tischlerplatte mit Spandeck
Lack | Beize | Furnier | HPL gemäß Hauskollektion

Tischkante

ABS-Kante | Buche massiv
Lack | Beize gemäß Hauskollektion

Klappbeschlag

Original delta 100.1
verchromt | polyamidbeschichtet
gemäß Hauskollektion

Zertifizierung

GS – Geprüfte Sicherheit

Preis

ab EUR 472,-

table height

740 - 750 mm

frame

round steel tube, flat oval steel tube
chrome-plated | polyamide-coated
according to house collection

table top

chipboard | wood core plywood
varnish | stains | wood veneer | HPL
according to house collection

table edge

ABS edge | solid beech
varnish | stains according to house collection

hinge

original delta 100.1
chrome-plated | polyamide-coated
according to house collection

certification

GS – tested safety

price

from EUR 472,-

KANTEN . EDGES

Kantenprofile 01 | 03 | 04 | 05 | 06 | 31 | 49

edge profiles 01 | 03 | 04 | 05 | 06 | 31 | 49

Ein Aufriss des Kantenaufbaus befindet sich auf Seite 273.

A layout of the edge configuration is presented on page 273.

GRÖSSEN . SIZES

rechteckig

rectangular

1400 - 1800 mm x 450 mm

1200 - 2000 mm x 600 mm

1200 - 2000 mm x 700 mm

1200 - 2000 mm x 800 mm

1200 - 2000 mm x 900 mm



262



285



279



291



281

ZUBEHÖR . ACCESSORIES



Direktschließendes
Kräfte Dreieck
directly closing
triangle of forces



Polyamidgleiter | Filzgleiter
polyamide glider | felt glider



höhenverstellbarer Gleiter
height-adjustable glider

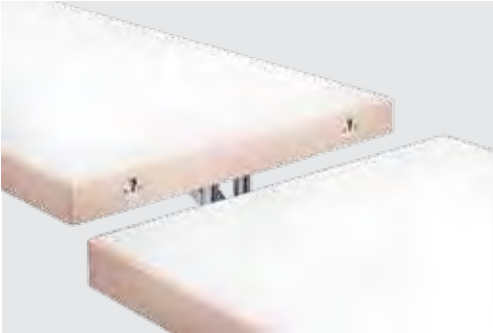

Einhängeplatten
intermediate table tops



Verbindung Eihängeplatten
connection of intermediate table tops



Klappbeschlag mit automatisch hochfahrendem Stapelklotz
hinge element with automatically upwards moving bearing block

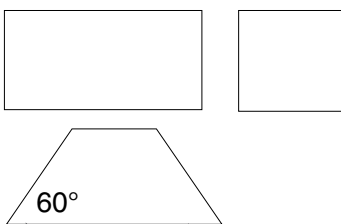

Varianten
variants



Sichtblende
screen

DELTA 100



delta 105 | Tischplatte mit weißem HPL belegt | Kante Buche massiv |
Gestell verchromt · table top with black HPL cover | solid beech edge |
chrome-plated frame



DELTA 100

Die KlappTischserie delta 100 verfügt über ein stabiles Doppelsäulen-Gestell aus Stahlrohr bzw. Buche massiv. Der patentierte Klappbeschlag delta 100 bietet mit seinem KräfteDreieck dauerhaften spiefreien Stand auch bei intensivem Einsatz. Verschiedene Gestellformen, Kantenprofile und diverse Plattenfarben stehen zur Auswahl.

The folding table series delta 100 is characterized by a solid frame with two pillars made of steel tube or solid beech. The patented delta 100 hinge, with its triangle of forces, provides a rock-solid platform with no play even when subjected to heavy use. Numerous edge profiles and a diverse selection of table top inserts are available.

DELTA 105



Tischplatte belegt mit weißem HPL | Gestell verchromt |
Kante Buche massiv · table top with white HPL cover |
chrome-plated frame | solid beech edge

AUSFÜHRUNG . DESIGN

Die Tische der delta-Kollektion sind in vielen verschiedenen Farben, Dekoren, Materialien und Veredelungen erhältlich.

The tables of the delta line are available in numerous colors, decors, materials and finishings.

DELTA 105**Tischhöhe**

740 - 750 mm

GestellRundstahlrohr verchromt | polyamidbeschichtet
gemäß Hauskollektion**Tischplatte**Spanplatte | Tischlerplatte mit Spandeck
Lack | Beize | Furnier | HPL gemäß Hauskollektion**Tischkante**ABS-Kante | Buche massiv
Lack | Beize | Furnier gemäß Hauskollektion**Klappbeschlag**

Original delta 100

Zertifizierung

GS – Geprüfte Sicherheit | Quality Office

Preis

ab EUR 462,-

table height

740 - 750 mm

frameround steel tube chrome-plated | polyamide-coated
according to house collection**table top**chipboard | wood core plywood
varnish | stains | wood veneer | HPL
according to house collection**edges**ABS edge | solid beech
varnish | stains according to house collection**hinge**

original delta 100

certification

GS – tested safety | Quality Office

price

from EUR 462,-

KANTEN . EDGES

Kantenprofile 01 | 03 | 04 | 05 | 06 | 31 | 49

edge profiles 01 | 03 | 04 | 05 | 06 | 31 | 49

Ein Aufriss des Kantenaufbaus befindet sich auf Seite 273.

A layout of the edge configuration is presented on page 273.

GRÖSSEN . SIZES

rechteckig

rectangular

1400 - 1800 mm x 450 mm

1200 - 2000 mm x 600 mm

1200 - 2000 mm x 700 mm

1200 - 2000 mm x 800 mm

1200 - 2000 mm x 900 mm

Die Tischgrößen sind von
den Kanten abhängig.Table sizes depend on
the edges.

262



285



279



291



281

ZUBEHÖR . ACCESSORIES



**Direktschließendes
Kräftedreieck**
directly closing
triangle of forces



Polyamidgleiter | Filzgleiter
polyamide glider | felt glider

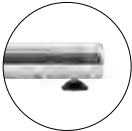

höhenverstellbarer Gleiter
height-adjustable glider

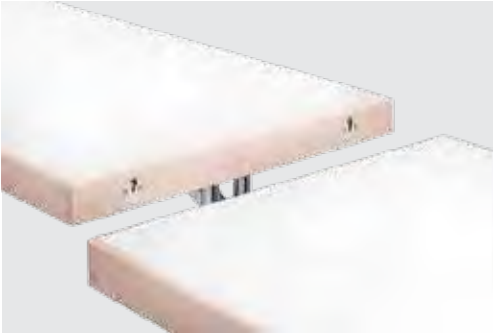

Einhängeplatten
intermediate table tops



Verbindung Einhängeplatten
connection of intermediate table tops



Klappbeschlag mit automatisch hochfahrendem Stapelklotz
hinge element with automatically upwards moving bearing block

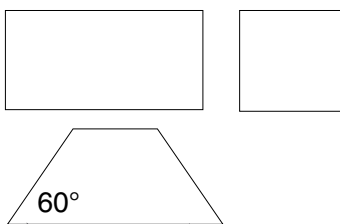

Varianten
variants



Sichtblende
screen

DELTA 104



Tischplatte belegt mit weißem HPL | Gestell polyamid-
beschichtet | Kante Buche massiv · table top with white
HPL cover | polyamide-coated frame | solid beech edge

AUSFÜHRUNG . DESIGN

Verschiedene Tischformen, Tischgrößen und Plattenmaterialien, umfangreiches Zubehör sowie eine große Auswahl an Farben und Dekoren ermöglichen die Anpassung an individuelle Raumkonzepte.

Various shapes and sizes of tables, board materials, accessories as well as a large variety of colors and decors allow the adjustment to individual room designs.

DELTA 104**Tischhöhe**

740 - 750 mm

Gestell

Vierkantstahlrohr
polyamidbeschichtet
gemäß Hauskollektion

Tischplatte

Spanplatte | Tischlerplatte mit Spandeck
Lack | Beize | Furnier | HPL gemäß Hauskollektion

Tischkante

ABS-Kante | Buche massiv
Lack | Beize | Furnier gemäß Hauskollektion

Klappbeschlag

Original delta 100

Zertifizierung

Quality Office

Preis

ab EUR 437,-

table height

740 - 750 mm

frame

square steel tube
polyamide-coated
according to house collection

table top

chipboard | wood core plywood
varnish | stains | wood veneer | HPL
according to house collection

edges

ABS edge | solid beech
varnish | stains according to house collection

hinge

original delta 100

certification

Quality Office

price

from EUR 437,-

KANTEN . EDGES

Kantenprofile 01 | 03 | 04 | 05 | 06 | 31

edge profiles 01 | 03 | 04 | 05 | 06 | 31

Ein Aufriss des Kantenaufbaus befindet sich auf Seite 273.

A layout of the edge configuration is presented on page 273.

GRÖSSEN . SIZES

rechteckig
rectangular

1400 - 1800 mm x 450 mm

1200 - 2000 mm x 600 mm

1200 - 2000 mm x 700 mm

1200 - 2000 mm x 800 mm

1200 - 2000 mm x 900 mm

Die Tischgrößen sind von
den Kanten abhängig.

Table sizes depend on
the edges.



262



285



279



291



281

DELTA 181



Tischplatte belegt mit weißem HPL | Gestell und Kante
Buche massiv · table top with white HPL cover | frame
and edge made of solid beech

AUSFÜHRUNG . DESIGN

Unterschiedliche Farben, Dekore, Materialien und Veredelungen bieten individuelle Gestaltungsmöglichkeiten.

The choice of different colors, decors, materials and finishings guarantee individual freedom when it comes to design options.

DELTA 181

Tischhöhe

740 - 750 mm

Gestell

Rundprofil Buche massiv
Lack | Beize gemäß Hauskollektion

Tischplatte

Spanplatte | Tischlerplatte mit Spandeck
Lack | Beize | Furnier | HPL gemäß Hauskollektion

Tischkante

ABS-Kante | Buche massiv
Lack | Beize | Furnier gemäß Hauskollektion

Klappbeschlag

Original delta 100

Preis

ab EUR 536,-

table height

740 - 750 mm

frame

round profile solid beech
varnish | stains according to house collection

table top

chipboard | wood core plywood
varnish | stains | wood veneer | HPL
according to house collection

edges

ABS edge | solid beech
varnish | stains according to house collection

hinge

original delta 100

price

from EUR 536,-

KANTEN . EDGES

Kantenprofile 01 | 03 | 04 | 05 | 06 | 31

edge profiles 01 | 03 | 04 | 05 | 06 | 31

Ein Aufriss des Kantenaufbaus befindet sich auf Seite 273.

A layout of the edge configuration is presented on page 273.

GRÖSSEN . SIZES

rechteckig
rectangular

1400 - 1800 mm x 450 mm

1200 - 2000 mm x 600 mm

1200 - 2000 mm x 700 mm

1200 - 2000 mm x 800 mm

Die Tischgrößen sind von den Kan-
ten abhängig.

Table sizes depend on the edges.



262



285



279



291



281

DELTA 158



-
- 1 Tischplatte belegt mit weißem HPL | Gestell verchromt | Kante Buche massiv · table top with white HPL cover | chrome-plated frame | solid beech edge
 - 2 Aus einem Tisch wird ein Stehtisch:
Erhöhung des Tisches durch Aufsteckhülsen
A table becomes a stand-up table:
table legs may be extended with slide-on connectors

AUSFÜHRUNG . DESIGN

Verschiedene Tischgrößen und Plattenmaterialien, umfangreiches Zubehör sowie eine große Auswahl an Farben und Dekoren ermöglichen die Anpassung an individuelle Raumkonzepte.

Various sizes of tables, board materials, accessories as well as a large variety of colors and decors allow the adjustment to individual room designs.

DELTA 158

Tischhöhe

740 - 750 mm

Gestell

Rundstahlrohr-DoppelfüÙe
verchromt | polyamidbeschichtet
gemäß Hauskollektion

Tischplatte

Spanplatte | Tischlerplatte mit Spandeck
Lack | Beize | Furnier | HPL gemäß Hauskollektion

Tischkante

Buche massiv
Lack | Beize | Furnier gemäß Hauskollektion

Klappbeschlag

Original delta 100

Preis

ab EUR 936,-

table height

740 - 750 mm

frame

round steel tube double columns
chrome-plated | polyamide-coated
according to house collection

table top

chipboard | wood core plywood
varnish | stains | wood veneer | HPL
according to house collection

edges

solid beech
varnish | stains | wood veneer
according to house collection

hinge

original delta 100

price

from EUR 936,-

KANTEN . EDGES

Kantenprofile 07 | 08 | 22
edge profiles 07 | 08 | 22

Ein Aufriss des Kantenaufbaus befindet sich auf Seite 273.
A layout of the edge configuration is presented on page 273.

GRÖSSEN . SIZES

rund
round

Ø1200 - 2000 mm



262



285



279



291



281

SYSTEM 24



EINFACH. FUNKTIONAL. ZUVERLÄSSIG.

HABEN SIE JEMALS DARÜBER NACHGEDACHT, WIE EINFACH ES IST, EINE TÜR ZU ÖFFNEN? NUR WAS GENIAL EINFACH IST, LÄSST SICH PRÄGNANT UND UNVERWECHSELBAR GESTALTEN. DESHALB IST ES EINE UNSERER WICHTIGSTEN AUFGABEN, INNOVATIONEN GANZ VERTRAUT UND SELBSTERKLÄREND ZU GESTALTEN.

Simple. Functional. Reliable.

Have you ever considered how easy it is to open a door? Only fantastically simple things can be designed in a distinctive way. Consequently one of our key tasks is to provide innovations with a familiar and self-descriptive appearance.



SYSTEM 24



Tischplatte belegt mit schwarzem HPL, hochglänzend | Gestellkom-
bination aus verchromtem Rundstahlrohr und schwarz gebeizten
Massivholz-Füßen - table top with black HPL cover, high-gloss | frame
combination of chrome-plated steel tube and black stained solid
wooden legs





SYSTEM 24

Die Klappertische der Serie system 24 kombinieren edles Design mit höchster Funktionalität. Die wahlweise gebogenen oder auf Gehrung geschnittenen Gestelle der system 24 Klappertische lassen sich dank des smarten Klappmechanismus seitlich leicht versetzt einklappen, sodass die Tische nicht nur einem intuitiven Bedienkonzept folgen, sondern sich zugleich auch sehr flach stapeln lassen. Eine besonders elegante Kombination aus Holz und Chrom in zylindrischer sowie in konischer Form zeigt sich in den Tischbeinen der Serie system 24 wood.

The folding tables in the system 24 series combine fine design with the highest level of functionality. The optionally curved or mitred underframes of the system 24 line can be folded at the sides slightly offset from one another thanks to their smart folding mechanism. Not only do the tables present an intuitive usage concept, they may be stacked extremely flat at the same time. The table legs of the system 24 wood line mirror an extraordinarily stylish combination of wood and chrome either in a cylindrical or conical shape.

SYSTEM 24 500 | 501

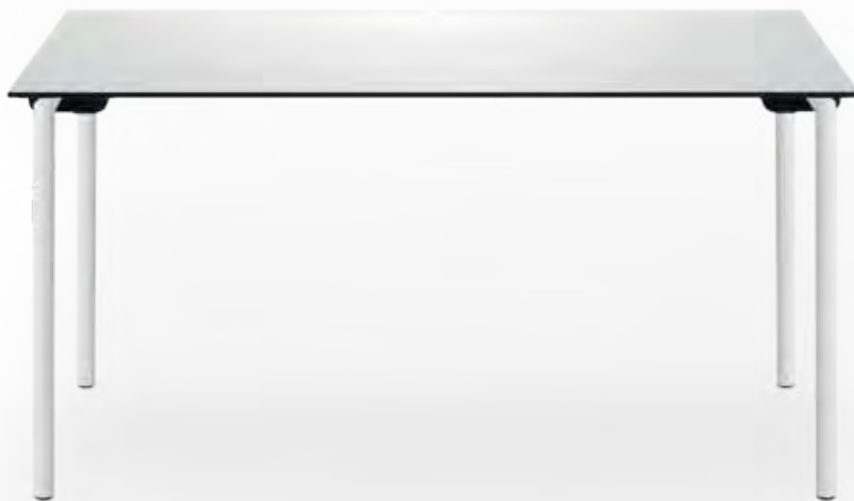

HPL-Vollkernplatte weiß mit schwarzer Kante, Gestell weiß pulverbeschichtet · white HPL solid core panel with black edge | white powder-coated frame

AUSFÜHRUNG . DESIGN

Unterschiedliche Farben, Dekore, Materialien und Veredelungen bieten individuelle Gestaltungsmöglichkeiten.

The choice of different colors, decors, materials and finishings guarantee individual freedom when it comes to design options.

SYSTEM 24 500 | 501**Tischhöhe**

740 - 750 mm

Gestell

Rundstahlrohr
verchromt | pulverbeschichtet
gemäß Hauskollektion

Tischplatte

Spanplatte | Vollkernplatte
Lack | Beize | Holzfurnier | HPL
gemäß Hauskollektion

Tischkante

ABS-Kante | Buche-Umleimer
Lack | Beize gemäß Hauskollektion
Vollkernplatte mit schwarzer Kante

Klappbeschlag

direktschließendes Kräffedreieck

Zertifizierung

GS – Geprüfte Sicherheit | Quality Office

Preis

ab EUR 542,-

table height

740 - 750 mm

frame

round steel tube
chrome-plated | powder-coated
according to house collection

table top

plywood | solid core panel
varnish | stains | veneer | HPL
according to house collection

table edges

ABS edge | edge banding made of beech
varnish | stains according to house collection
solid core panel: black edge

hinge

directly closing triangle of forces

certification

GS – tested safety | Quality Office

price

from EUR 542,-

KANTEN . EDGES

Kantenprofile 14 | 30 | 32

edge profiles 14 | 30 | 32

Ein Aufriss des Kantenaufbaus befindet sich auf Seite 273.

A layout of the edge configuration is presented on page 273.

GESTELLFORMEN . FRAME TYPES

500



501

GRÖSSEN . SIZES

quadratisch
square

800 x 800 mm



rechteckig
rectangular

900 - 1800 x 600 mm
900 - 1800 x 700 mm
900 - 1800 x 800 mm



rund
round

Ø 1000 - 1400 mm



262



285



279



291



281

EINHÄNGEPLATTEN . INTERMEDIATE TABLE TOPS

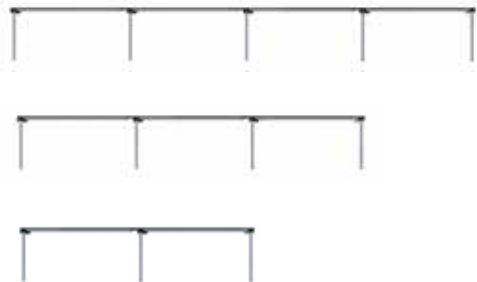
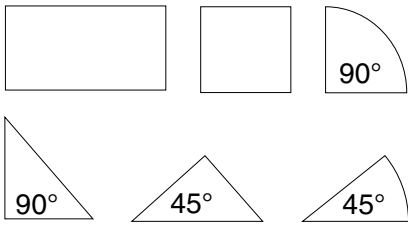

Varianten
variants

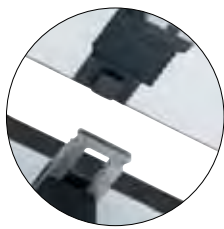

feste Verbindung
lock | unlock



Einhängeplatte Rechteck
intermediate table top, rectangular



Einhängeplatte gerundet
intermediate table top, rounded



Einhängeplatte Dreieck
intermediate table top, triangular

AUFBEWAHRUNG . STORAGE

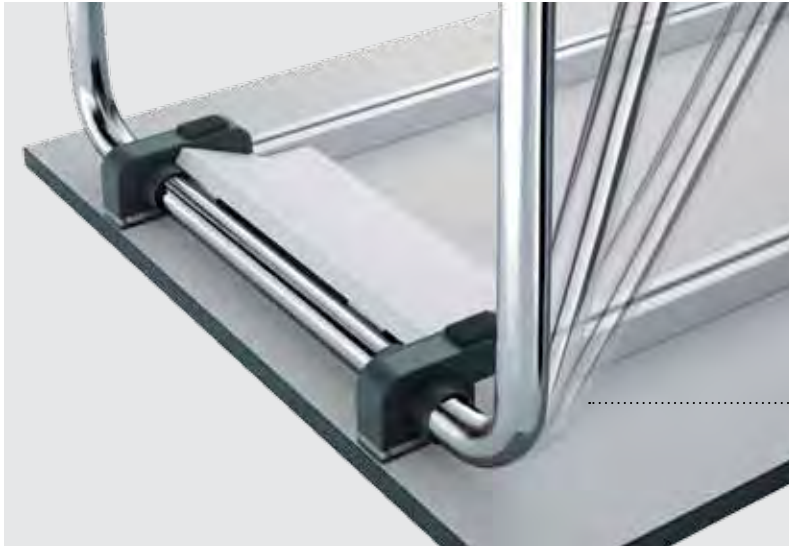

Lagerbock | Klappmechanik
direktschließendes Kräftedreieck
bearing block | closing mechanism
directly closing triangle of forces



DRÜCKERPLATTE. PRESSURE PANEL

Die Drückerplatte ist besonders handlich und einfach zu bedienen. Sie erleichtert das Einklappen zugunsten eines zügigen Auf- und Abbaus des Tisches.

The pressure panel is very handy and easy to use. It guarantees an easy and speedy folding of the table.

SYSTEM 24

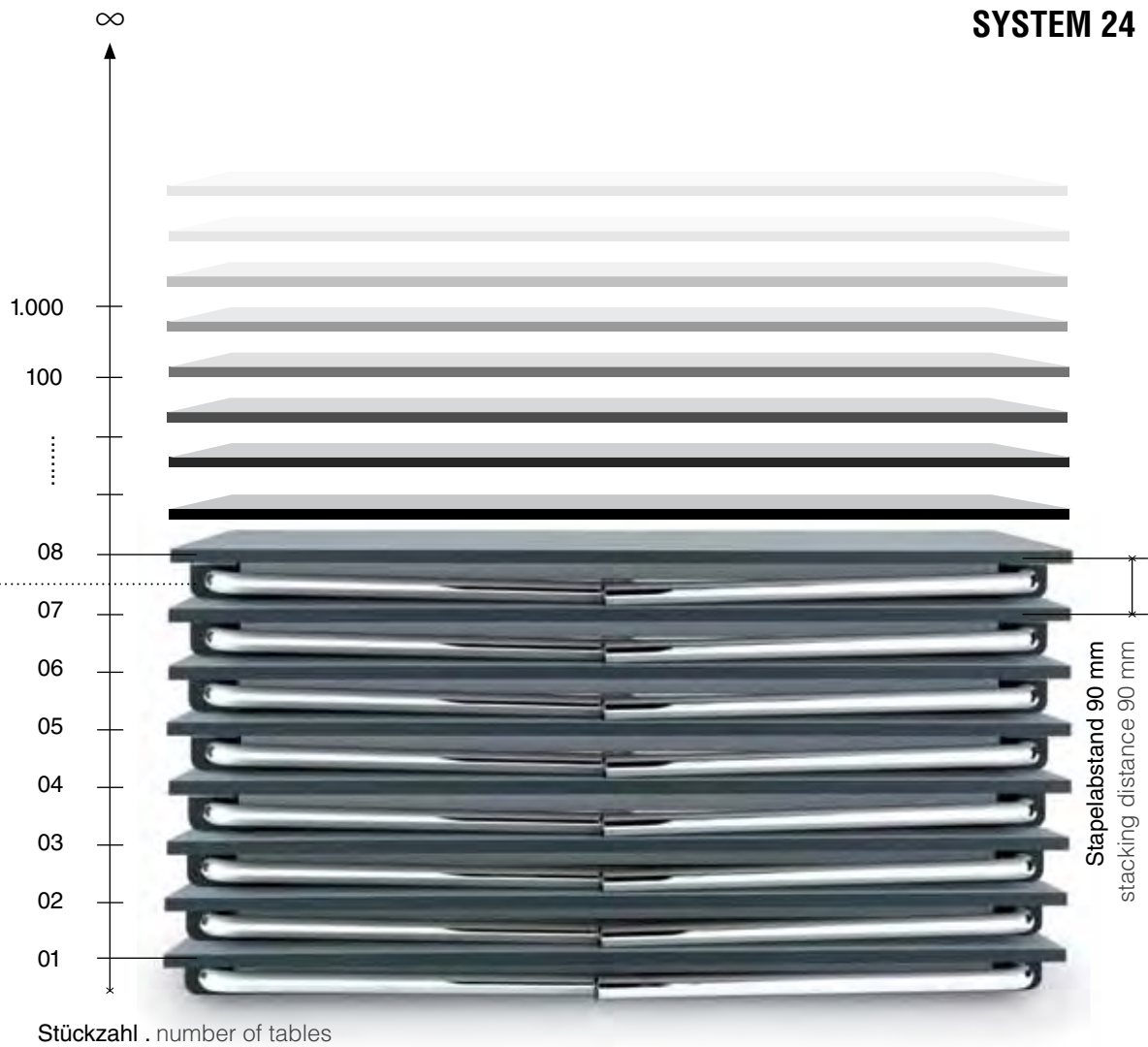

aufgehängt
suspended



Tischwagen 002
table trolley 002



Tischwagen 001
table trolley 001

ZUBEHÖR . ACCESSORIES



Rolle
castor

SICHTBLENDEN . SCREENS



Sichtblendenbefestigung "Design"
screen fixation "design"





Connector
connector



Befestigung
fixation



Sichtblendenbefestigung "Classic"
screen fixation "classic"



SYSTEM 24 WOOD



Tischplatte belegt mit Holzfurnier, Gestellkombination aus verchromtem Rundstahlrohr und konifizierten Massivholz-Füßen · table top with wood veneer | frame combination of chrome-plated steel tube and conified solid wooden legs

AUSFÜHRUNG . DESIGN

Unterschiedliche Farben, Dekore, Materialien und Veredelungen bieten individuelle Gestaltungsmöglichkeiten.

The choice of different colors, decors, materials and finishings guarantee individual freedom when it comes to design options.

SYSTEM 24 WOOD

Tischhöhe

740 - 750 mm

Gestell

Buche massiv
 zylindrisch | konisch verlaufend
 Lack | Beize gemäß Hauskollektion

Tischplatte

Spanplatte | Vollkernplatte
 Lack | Beize | Holz furnier | HPL
 gemäß Hauskollektion

Tischkante

ABS-Kante | Buche-Umleimer
 Lack | Beize gemäß Hauskollektion
 Vollkernplatte mit schwarzer Kante

Klappbeschlag

direktschließendes Kräffedreieck

Preis

ab EUR 741,-

table height

740 - 750 mm

frame

solid beech
 cylindrical | conically shaped
 varnish | stains according to house collection

table top

plywood | solid core panel
 varnish | stains | veneer | HPL
 according to house collection

table edges

ABS edge | edge banding made of beech
 varnish | stains according to house collection
 solid core panel: black edge

hinge

directly closing triangle of forces

price

from EUR 741,-

KANTEN . EDGES

Kantenprofile 14 | 30 | 32

edge profiles 14 | 30 | 32

Ein Aufriss des Kantenaufbaus befindet sich auf Seite 273.

A layout of the edge configuration is presented on page 273.

GESTELLFORMEN . FRAME TYPES



503

konisch verlaufend
 conically shaped



504

zylindrisch
 cylindrical

GRÖSSEN . SIZES



quadratisch
 square

800 x 800 mm



rechteckig
 rectangular

900 - 1800 mm x 600 mm
 900 - 1800 mm x 700 mm
 900 - 1800 mm x 800 mm



rund
 round

Ø 1000 - 1400 mm



262



285



279



291



281

SYSTEM 24 SOLITÄR



weiße HPL-Vollkernplatte mit schwarzer Kante | Gestell aus verchromtem Stahlrohr · white HPL solid core panel with black edge | frame made of chrome-plated steel tube

AUSFÜHRUNG . DESIGN

Unterschiedliche Farben, Dekore, Materialien und Veredelungen bieten individuelle Gestaltungsmöglichkeiten.

The choice of different colors, decors, materials and finishings guarantee individual freedom when it comes to design options.

SYSTEM 24 SOLITÄR

Tischhöhe
740 - 750 mm

Gestell

Rundstahlrohr
FüÙe 5° ausgestellt
verchromt | pulverbeschichtet
gemäß Hauskollektion

Tischplatte

Tischlerplatte mit Spandeck
Schichtholzplatte | Vollkernplatte
Lack | Beize | Furnier | HPL
gemäß Hauskollektion

Tischkante

ABS-Kante | Buche-Umleimer
Lack | Beize gemäß Hauskollektion
schwarze Kante bei Vollkernplatte

Klappbeschlag

direktschließendes KräÙtedreieck

Preis

ab EUR 699,-

table height
740 - 750 mm

frame

round steel tube
legs exposed 5°
chrome-plated | powder-coated
according to house collection

table top

wood core plywood | plywood | solid core panel
varnish | stains | veneer | HPL
according to house collection

table edges

ABS edge | edge banding made of beech
varnish | stains according to house collection
solid core panel: black edge

hinge

directly closing triangle of forces

price

from EUR 699,-

KANTEN . EDGES

Kantenprofile Modell 510: 14 | 30 | 32 | 34

Kantenprofile Modell 511: 14 | 30 | 32 | 36

Kantenprofil ovaler Tisch: 12

edge profiles model 510: 14 | 30 | 32 | 34

edge profiles model 511: 14 | 30 | 32 | 36

edge profile oval table: 12

Ein Aufriss des Kantenaufbaus befindet sich auf Seite 273.

A layout of the edge configuration is presented on page 273.

PLATTENFORMEN . TABLE TOP TYPES

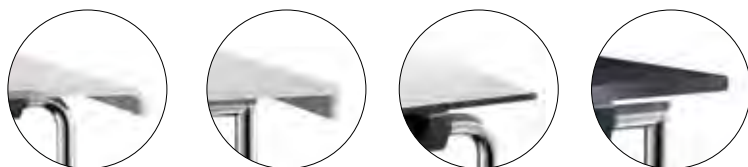

GESTELLFORMEN . FRAME TYPES



510

gebogen | bent

511

auf Gehrung geschweiÙt | mitred

GRÖSSEN . SIZES



oval

oval

2000 x 1000 mm



rechteckig

rectangular

1600-2100 mm x 700 mm

1600-2100 mm x 800 mm

1600-2100 mm x 900 mm



262



285



279



291



281

206 · 207



-
- 1 207 | HPL-Vollkernplatte weiß mit schwarzer Kante, Gestell
weiß pulverbeschichtet · white HPL solid core panel with black
edge, frame white powder-coated



1



206 | 207

Die Tische 206 und 207 sind Vierfüßtische mit Bügelfüßen aus Vierkantstahlrohr [206] bzw. Rundstahlrohr [207] in verchromter oder pulverbeschichteter Ausführung. Stabilität erhält das Gestell durch das durchgängige Längszargenprofil. Die Tischplatten können mit HPL belegt werden und sind somit kratzfest, lichtecht sowie gegen Zigaretten- glut beständig. Optional können die Tische auch mit einer eleganten, 10 mm dünnen Vollkernplatte ausgestattet werden.

The 206 and 207 non-folding tables are equipped with arched legs made of tubular steel [206] respectively round steel [207] either chrome-plated or powder-coated. A continuous side rail profile leaves the frame exceptionally stable and solid. The HPL covered tabletops are scratch-proof, lightfast and resistant to cigarette burns. The tables can be equipped with an elegant, 10 mm thin solid core panel upon request.



HPL-Vollkernplatte | Gestell verchromt
HPL solid core panel | chrome-plated frame

AUSFÜHRUNG . DESIGN

Unterschiedliche Farben, Dekore und Materialien bieten individuelle Gestaltungsmöglichkeiten.

The choice of different colors, decors and materials guarantee individual freedom when it comes to design options.

Tischhöhe

740 mm

Gestell

Bügelfüße aus Vierkantstahlrohr
verchromt | pulverbeschichtet
gemäß Hauskollektion

Tischplatte

Spanplatte | Vollkernplatte
Lack | Beize | Furnier | HPL
gemäß Hauskollektion

Tischkante

ABS-Kante | Buche-Umleimer
Lack | Beize gemäß Hauskollektion
schwarze Kante bei Vollkernplatte

Zertifizierung

GS – Geprüfte Sicherheit | Quality Office

Preis

ab EUR 410,-

table height

740 mm

frame

arched legs made of square steel tube
chrome-plated | powder-coated
according to house collection

table top

chipboard | solid core panel
varnish | stains | HPL
according to house collection

table edges

ABS edge | edge banding made of beech
varnish | stains according to house collection
solid core panel: black edge

certification

GS – tested safety | Quality Office

price

from EUR 410,-

KANTEN . EDGES

Kantenprofile 14 | 30 | 32

Kantenprofile 14 | 30 | 32

Ein Aufriss des Kantenaufbaus befindet sich auf Seite 273.

A layout of the edge configuration is presented on page 273.

GRÖSSEN . SIZES

quadratisch
square

600 x 600 mm
700 x 700 mm
800 x 800 mm
900 x 900 mm



rechteckig
rectangular

1000-2000 mm x 600 mm
1000-2000 mm x 700 mm
1000-2000 mm x 800 mm
1000-2000 mm x 900 mm



262



285



279



291



281



HPL-Vollkernplatte | Gestell verchromt
HPL solid core panel | chrome-plated frame

AUSFÜHRUNG . DESIGN

Verschiedene Tischformen, Tischgrößen und Plattenmaterialien, umfangreiches Zubehör sowie eine große Auswahl an Farben und Dekoren ermöglichen die Anpassung an individuelle Raumkonzepte.

Various shapes and sizes of tables, board materials, accessories as well as a large variety of colors and decors allow the adjustment to individual room designs.

Tischhöhe

740 mm

Gestell

Bügelfüße aus Rundstahlrohr
verchromt | pulverbeschichtet
gemäß Hauskollektion

Tischplatte

Spanplatte | Vollkernplatte
Lack | Beize | Furnier | HPL
gemäß Hauskollektion

Tischkante

ABS-Kante | Buche-Umleimer
Lack | Beize gemäß Hauskollektion
schwarze Kante bei Vollkernplatte

Zertifizierung

GS – Geprüfte Sicherheit | Quality Office

Preis

ab EUR 367,-

table height

740 mm

frame

arched legs made of round steel tube
chrome-plated | powder-coated
according to house collection

table top

chipboard | solid core panel
varnish | stains | HPL
according to house collection

table edges

ABS edge | edge banding made of beech
varnish | stains according to house collection
solid core panel: black edge

certification

GS – tested quality | Quality Office

price

from EUR 367,-

KANTEN . EDGES

Kantenprofile 14 | 30 | 32

edge profiles 14 | 30 | 32

Ein Aufriss des Kantenaufbaus befindet sich auf Seite 273.

A layout of the edge configuration is presented on page 273.

GRÖSSEN . SIZES

quadratisch
square

600 x 600 mm
700 x 700 mm
800 x 800 mm
900 x 900 mm



rechteckig
rectangular

1000-2000 mm x 600 mm
1000-2000 mm x 700 mm
1000-2000 mm x 800 mm
1000-2000 mm x 900 mm



262



285



279



291



281

LOGO TABLE



-
- 1 Tischplatte mit schneeweißem Dekor | Gestell verchromt
table top with gray white decor | chrome-plated frame



1



LOGOTABLE

Hohen Variantenreichtum zu einem günstigen Preis bieten die stapelbaren Tische der Serie logotable. Das Gestell des logotable 306 besteht aus Vierkantstahlrohr, aus rundem Stahlrohr besteht das Gestell des Tisches logotable 307. Diverse Oberflächendekore, Tischkanten, -platten und -formen sowie verschiedene Gestellveredelungen bieten individuelle Gestaltungsmöglichkeiten.

With its enormous versatility at a moderate price level the logotable line offers perfect stacking possibilities. The frame of logotable 306 consists of a steel-square tube, the frame of logotable 307 is made of round-shaped tubular steel. Numerous surface decors, table edge variants, frame finishings, table tops and table forms offer individual design options.

LOGOTABLE 306



Tischplatte mit schneeweißem Dekor | Gestell verchromt
table top with gray white decor | chrome-plated frame

AUSFÜHRUNG . DESIGN

Verschiedene Tischformen, Tischgrößen und Plattenmaterialien, umfangreiches Zubehör sowie eine große Auswahl an Farben und Dekoren ermöglichen die Anpassung an individuelle Raumkonzepte.

Various shapes and sizes of tables, board materials, accessories as well as a large variety of colors and decors allow the adjustment to individual room designs.

LOGOTABLE 306

Tischhöhe

730 - 740 mm

Gestell

Vierkantstahlrohr
verchromt | polyamidbeschichtet
gemäß Hauskollektion

Tischplatte

Spanplatte | Vollkernplatte
direktbeschichtete Platte

Tischkante

ABS-Kante
bei Vollkernplatte: schwarze Kante

Stapelung

Tische sind verdreht stapelbar

Zertifizierung

GS – Geprüfte Sicherheit

Preis

ab EUR 194,-

DEKORFARBEN . FINISH COLORS



Schneeweiß
gray white



Steingrau
stone gray



Maulwurfgrau
mouse gray



Nachtschwarz
midnight black

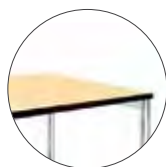

Zitronengelb
lemon yellow



Lime
lime



Orchidee
orchid



Rostrot
rusty red

KANTEN . EDGES

Kantenprofile 30 | 32
edge profiles 30 | 32

Ein Aufriss des Kantenaufbaus befindet sich auf Seite 273.
A layout of the edge configuration is presented on page 273.

GRÖSSEN . SIZES



quadratisch
square

700 x 700 mm
800 x 800 mm



rechteckig
rectangular

1400 x 700 mm
1400 x 800 mm

table height

730 - 740 cm

frame

square steel tube
chrome-plated | polyamide-coated
according to house collection

table top

chipboard | solid core panel
directly coated table top

edges

ABS edge | solid core panel with black edge

stacking

tables are easy to stack in a staggered formation

certification

GS – tested safety

price

from EUR 194,-



262



285



279



291



281

LOGOTABLE 307



HPL-Vollkernplatte in Schneeweiß | Gestell verchromt
white HPL solid core panel in gray white
chrome-plated frame

AUSFÜHRUNG . DESIGN

Unterschiedliche Farben, Dekore, Materialien und Veredelungen bieten individuelle Gestaltungsmöglichkeiten.

The choice of different colors, decors, materials and finishings guarantees individual freedom when it comes to design options.

LOGOTABLE 307

Tischhöhe

730 - 740 mm

Gestell

Rundstahlrohr
verchromt | polyamidbeschichtet
gemäß Hauskollektion

Tischplatte

Spanplatte | Vollkernplatte
direktbeschichtete Spanplatte

Tischkante

ABS-Kante
bei Vollkernplatte: schwarze Kante

Stapelung

Tische sind verdreht stapelbar

Zertifizierung

GS – Geprüfte Sicherheit

Preis

ab EUR 184,-

DEKORFARBEN . FINISH COLORS



Schneeweiß
gray white



Steingrau
stone gray



Maulwurfgrau
mouse gray



Nachtschwarz
midnight black



Zitronengelb
lemon yellow



Lime
lime



Orchidee
orchid



Rostrot
rusty red

KANTEN . EDGES

Kantenprofile 30 | 32
edge profiles 30 | 32

Ein Aufriss des Kantenaufbaus befindet sich auf Seite 273.
A layout of the edge configuration is presented on page 273.

GRÖSSEN . SIZES



quadratisch
square

700 x 700 mm
800 x 800 mm



rechteckig
rectangular

1400 x 700 mm
1400 x 800 mm

table height

730 - 740 mm

frame

round steel tube
chrome-plated | polyamide-coated
according to house collection

table top

chipboard | solid core panel
directly coated table top

edges

ABS edge | solid core panel with black edge

stacking

tables are easy to stack in a staggered formation

certification

GS – tested safety

price

from EUR 184,-



262



285



279



291



281

TABULA LIGHT



-
- 1 Tischplatte mit weißem HPL belegt | Vierkant-Holzgestell, weiß
gebeizt · table top with white HPL cover | wooden square frame,
stained in white

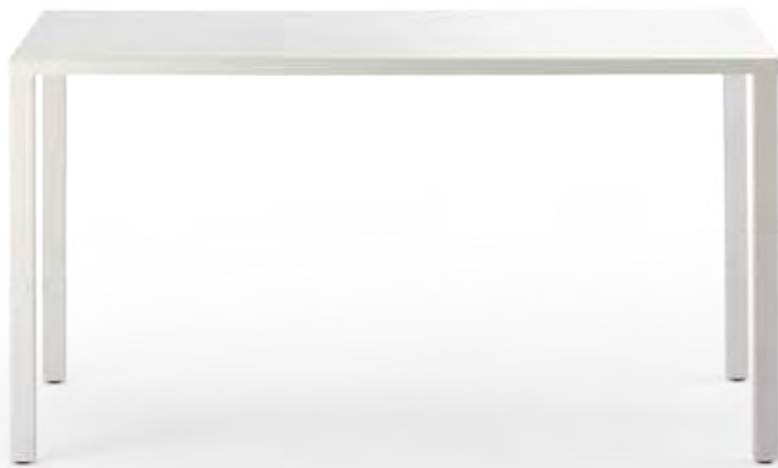

1

TABULA LIGHT

Die Tische der Serie tabula vereinen einen hohen Variantenreichtum mit einheitlichem Design. Durch verschiedene Fußvarianten aus Stahl und Holz sowie passende Tischformen und -größen, Tischkanten und funktionales Zubehör bietet tabula individuelle Gestaltungsmöglichkeiten. Tischplatten, die mit HPL belegt sind, sind kratzfest, lichtecht sowie gegen Zigarettenglut beständig.



The tabula table series unites great diversity with standardized design. With various leg types in steel and wood as well as matching table shapes and sizes, edges, and functional accessories, tabula makes customized designs possible. Table tops covered with HPL are scratch-resistant, light-fast and resistant to cigarette burns.

TABULA LIGHT 2010



Tischplatte mit weißem HPL belegt | Gestell aus Rundstahlrohr, verchromt, versenkte Anschraubplatte
table top with white HPL cover | frame made of chrome-plated round steel, recessed metal bracket

AUSFÜHRUNG . DESIGN

Verschiedene Tischformen, Tischgrößen und Plattenmaterialien, umfangreiches Zubehör sowie eine große Auswahl an Farben und Dekoren ermöglichen die Anpassung an individuelle Raumkonzepte.

Various shapes and sizes of tables, board materials, accessories as well as a large variety of colors and decors allow the adjustment to individual room designs.

TABULA LIGHT 2010

Tischhöhe

740 mm

Gestell

Rundstahlrohr
verchromt | polyamidbeschichtet
gemäß Hauskollektion
Befestigung über Metallkonsolen

Tischplatte

Spanplatte
Lack | Beize | Holzfurnier | HPL
gemäß Hauskollektion

Tischkante

ABS-Kante | Buche-Umleimer
Buche-Einleimer, gefast oder gerundet
Lack | Beize gemäß Hauskollektion

Preis

ab EUR 308,-

table height

740 mm

frame

brushed stainless steel | round steel tube
chrome-plated | polyamide-coated
according to house collection
fixed with metal brackets

table top

chipboard
varnish | stains | wood veneer | HPL
according to house collection

table edge

ABS edge | beech edge surround
beech edging, rounded or bevelled
varnish | stains according to house collection

price

from EUR 308,-

KANTEN . EDGES

Kantenprofile 2030 | 2060 | 2050 | 2051
edge profiles 2030 | 2060 | 2050 | 2051

Ein Aufriss des Kantenaufbaus befindet sich auf Seite 273.
A layout of the edge configuration is presented on page 273.



sichtbare
Metallkonsole
visible metal
bracket



optional: Metallkonsole in
Tischplatte versenkt
optional: metal bracket is
recessed neatly in table top

GRÖSSEN . SIZES



quadratisch
square

600 x 600 mm
700 x 700 mm
800 x 800 mm
900 x 900 mm

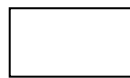

rechteckig
rectangular

1200 x 600 mm
1200-1400 mm x 700 mm
1200-1600 mm x 800 mm



rund
round

Ø 600 - 1200 mm



halbrund
halfround

Ø 1200 - 1600 mm

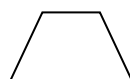

trapezförmig
trapezoidal

1200 x 600 x 600 mm
1400 x 700 x 700 mm
1600 x 800 x 800 mm



262



285



279



291



281

TABULA LIGHT 2040



Tischplatte mit Holzfurnier belegt | Gestell aus Vierkantstahlrohr, verchromt, versenkte Anschraubplatte
table top with wood veneer | frame made of chrome-plated square steel, recessed metal bracket

AUSFÜHRUNG . DESIGN

Unterschiedliche Farben, Dekore, Materialien und Veredelungen bieten individuelle Gestaltungsmöglichkeiten.

The choice of different colors, decors, materials and finishings guarantees individual freedom when it comes to design options.

TABULA LIGHT 2040

Tischhöhe

740 mm

Gestell

Vierkantstahlrohr
verchromt | polyamidbeschichtet
gemäß Hauskollektion
Befestigung über Metallkonsolen

Tischplatte

Spanplatte
Lack | Beize | Holzfurnier | HPL
gemäß Hauskollektion

Tischkante

ABS-Kante gemäß | Buche-Umleimer
Buche-Einleimer, gefast oder gerundet
Lack | Beize gemäß Hauskollektion

Preis

ab EUR 312,-

table height

740 mm

frame

brushed stainless steel | square steel tube
chrome-plated | polyamide-coated
according to house collection
fixed with metal brackets

table top

chipboard
varnish | stains | wood veneer | HPL
according to house collection

table edge

ABS edge | beech edge surround
beech edging, rounded or bevelled
varnish | stains according to house collection

price

from EUR 312,-

KANTEN . EDGES

Kantenprofile 2030 | 2060 | 2050
edge profiles 2030 | 2060 | 2050

Ein Aufriss des Kantenaufbaus befindet sich auf Seite 273.
A layout of the edge configuration is presented on page 273.

GESTELLFORMEN . FRAME TYPES



sichtbare
Metallkonsole
visible metal
bracket



optional: Metallkonsole in
Tischplatte versenkt
optional: metal bracket is
recessed neatly in table top

GRÖSSEN . SIZES



quadratisch
square

600 x 600 mm
700 x 700 mm
800 x 800 mm
900 x 900 mm

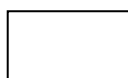

rechteckig
rectangular

1200 x 600 mm
1200-1400 x 700 mm
1200-1600 x 800 mm



rund
round

Ø 600 - 1200 mm



halbrund
halfround

Ø 1200 - 1600 mm

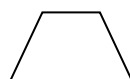

trapezförmig
trapezoidal

1200 x 600 x 600 mm
1400 x 700 x 700 mm
1600 x 800 x 800 mm



262



285



279



291



281

TABULA LIGHT 2000



Tischplatte mit Holzfurnier belegt | Gestell mit Rundstollen aus massiver Buche, natur lackiert, versenkte Anschraubplatte · table top with wood veneer | frame with round legs made of solid beech, natural varnish, recessed metal bracket

AUSFÜHRUNG . DESIGN

Die Tische der tabula light Kollektion sind in vielen verschiedenen Farben, Dekoren, Materialien und Veredelungen erhältlich.

The tables of the tabula light line are available in numerous colors, decors, materials and finishings.

TABULA LIGHT 2000

KANTEN . EDGES

Kantenprofile 2030 | 2060 | 2050 | 2051
edge profiles 2030 | 2060 | 2050 | 2051

Ein Aufriss des Kantenaufbaus befindet sich auf Seite 273.
A layout of the edge configuration is presented on page 273.

GESTELLFORMEN . FRAME TYPES



sichtbare
Metallkonsole
visible metal
bracket



optional: Metallkonsole
in Tischplatte versenkt
optional: metal bracket
recessed in table top



optional: ohne Metallstützen,
Metallkonsole versenkt
optional: without metal nozz-
les, recessed metal bracket

GRÖSSEN . SIZES



quadratisch
square

600 x 600 mm
700 x 700 mm
800 x 800 mm
900 x 900 mm

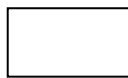

rechteckig
rectangular

1200 x 600 mm
1200 - 1400 x 700 mm
1200 - 1600 x 800 mm



rund
round

Ø 600 - 1200 mm



halbrund
halfround

Ø 1200 - 1600 mm

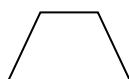

trapezförmig
trapezoidal

1200 x 600 x 600 mm
1400 x 700 x 700 mm
1600 x 800 x 800 mm

Tischhöhe

740 mm

Gestell

Buche massiv, Rundstollen
Lack | Beize gemäß Hauskollektion
Befestigung über Metallkonsolen

Tischplatte

Spanplatte
Lack | Beize | Holz furnier | HPL
gemäß Hauskollektion

Tischkante

ABS-Kante | Buche-Umleimer
Buche-Einleimer, gefast oder gerundet
Lack | Beize gemäß Hauskollektion

Preis

ab EUR 295,-

table height

740 mm

frame

solid beech, round legs
varnish | stains according to house collection
fixed with metal brackets

table top

chipboard
varnish | stains | wood veneer | HPL
according to house collection

table edge

ABS edge | beech edge surround
beech edging, rounded or bevelled
varnish | stains according to house collection

price

from EUR 295,-



262



279



291



281

TABULA LIGHT 2020



Tischplatte mit Holzfurnier belegt | Gestell mit Quadrastollen aus massiver Buche, natur lackiert, versenkte Anschraubplatte · table top with wood veneer | frame with square legs made of solid beech, natural varnish, recessed metal bracket

AUSFÜHRUNG . DESIGN

Unterschiedliche Farben, Dekore, Materialien und Veredelungen bieten individuelle Gestaltungsmöglichkeiten.

The choice of different colors, decors, materials and finishings guarantees individual freedom when it comes to design options.

TABULA LIGHT 2020

KANTEN . EDGES

Kantenprofile 2030 | 2060 | 2050
edge profiles 2030 | 2060 | 2050

Ein Aufriss des Kantenaufbaus befindet sich auf Seite 273.
A layout of the edge configuration is presented on page 273.

GESTELLFORMEN . FRAME TYPES



sichtbare
Metallkonsole
visible metal
bracket



optional: Metallkonsole
in Tischplatte versenkt
optional: metal bracket
recessed in table top



optional: ohne Metallstützen,
Metallkonsole versenkt
optional: without metal nozz-
les, recessed metal bracket

GRÖSSEN . SIZES



quadratisch
square

600 x 600 mm
700 x 700 mm
800 x 800 mm
900 x 900 mm

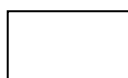

rechteckig
rectangular

1200 x 600 mm
1200- 1400 x 700 mm
1200- 1600 x 800 mm



rund
round

Ø 600 - 1200 mm



halbrund
halfround

Ø 1200- 1600 mm

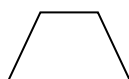

trapezförmig
trapezodial

1200 x 600 x 600 mm
1400 x 700 x 700 mm
1600 x 800 x 800 mm

Tischhöhe

740 mm

Gestell

Buche massiv, Quadratstollen
Lack | Beize gemäß Hauskollektion
Befestigung über Metallkonsolen

Tischplatte

Spanplatte
Lack | Beize | Holz furnier | HPL
gemäß Hauskollektion

Tischkante

ABS-Kante | Buche-Umleimer
Buche-Einleimer, gefast oder gerundet
Lack | Beize gemäß Hauskollektion

Preis

ab EUR 293,-

table height

740 mm

frame

solid beech, square
varnish | stains according to house collection
fixed with metal brackets

table top

chipboard
varnish | stains | wood veneer | HPL
according to house collection

table edge

ABS edge | beech edge surround
beech edging, rounded or bevelled
varnish | stains according to house collection

price

from EUR 293,-



262



279



291



281

TABULA LIGHT 2030



Tischplatte mit Holzfurnier belegt | Gestell mit Metallkonsolen und Quadratstollen aus massiver Buche, natur lackiert, versenkte Anschraubplatte · table top with wood veneer | frame with metal nozzles and square legs made of solid beech, natural varnish, recessed metal bracket

AUSFÜHRUNG . DESIGN

Verschiedene Tischformen, Tischgrößen und Plattenmaterialien, umfangreiches Zubehör sowie eine große Auswahl an Farben und Dekoren ermöglichen die Anpassung an individuelle Raumkonzepte.

Various shapes and sizes of tables, board materials, accessories as well as a large variety of colors and decors allow the adjustment to individual room designs.

TABULA LIGHT 2030

Tischhöhe

740 mm

Gestell

Buche massiv, Quadratstollen
konisch verlaufend
Lack | Beize gemäß Hauskollektion
Befestigung über Metallkonsolen

Tischplatte

Spanplatte
Lack | Beize | Holzfurnier | HPL
gemäß Hauskollektion

Tischkante

ABS-Kante | Buche-Umleimer
Buche-Einleimer, gefast oder gerundet
Lack | Beize gemäß Hauskollektion

Preis

ab EUR 317,-

table height

740 mm

frame

solid beech, square legs
conically shaped
varnish | stains according to house collection
fixed with metal brackets

table top

chipboard
varnish | stains | wood veneer | HPL
according to house collection

table edge

ABS edge | beech edge surround
beech edging, rounded or bevelled
varnish | stains according to house collection

price

from EUR 317,-

KANTEN . EDGES

Kantenprofile 2030 | 2060 | 2050

edge profiles 2030 | 2060 | 2050

Ein Aufriss des Kantenaufbaus befindet sich auf Seite 273.

A layout of the edge configuration is presented on page 273.

GESTELLFORMEN . FRAME TYPES



sichtbare
Metallkonsole
visible metal
bracket



optional: Metallkonsole in
Tischplatte versenkt
optional: metal bracket is
recessed neatly in table top



optional: ohne Metallstutzen,
Metallkonsole versenkt
optional: without metal nozzles,
recessed metal bracket

GRÖSSEN . SIZES



quadratisch
square

600 x 600 mm
700 x 700 mm
800 x 800 mm
900 x 900 mm

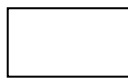

rechteckig
rectangular

1200 x 600 mm
1200-1400 x 700 mm
1200-1600 x 800 mm



rund
round

Ø 600 - 1200 mm



halbrund
halfround

Ø 1200 - 1600 mm

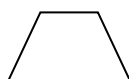

trapezförmig
trapezoidal

1200 x 600 x 600 mm
1400 x 700 x 700 mm
1600 x 800 x 800 mm



262



279



291



281

4 1 0 · 4 1 1 · 4 1 2



1 411 Tischplatte mit Holzfurnier belegt | Gestell Buche massiv, gebeizt
table top with wood veneer | frame made of stained solid beech



1

TISCHE . TABLES

Die Holztische 410 und 411 sind dank ihrer schlichten Gestaltung wahre Alleskönner. Die Rechteck- bzw. Quadratstollen aus massivem Buchenholz verleihen den Tischen soliden Stand. Die Holztische 410 und 411 sind in vielen verschiedenen Größen erhältlich. Der Holz-Stehtisch 412 ergänzt die Reihe.

Due to their minimalist design the wooden tables 410 and 411 are genuine all-rounders. The rectangular or square-profiled legs made of massive beech wood add extraordinary stability to these tables. The 410 and 411 wooden tables can be customized in various table sizes. The wooden stand-up table 412 complements the range.

TISCH 410 . TABLE 410



Tischplatte mit Holzfurnier | Gestell Buche massiv,
gebeizt
table top with wood veneer | stained solid wooden
frame

AUSFÜHRUNG . DESIGN

Die Tische sind in vielen verschiedenen Farben,
Dekoren, Materialien und Veredelungen erhältlich.

The tables of the tabula light line are available in
numerous colors, decors, materials and finishings.

Tischhöhe

740 mm

GestellBuche massiv, Rechteckstollen
Lack | Beize gemäß Hauskollektion**Tischplatte**Tischlerplatte mit Spandeck
Lack | Beize | Holzfurnier | HPL
gemäß Hauskollektion**Tischkante**Buche Vollholz
Lack | Beize gemäß Hauskollektion**Preis**

ab EUR 614,-

table height

740 mm

framesolid beech, rectangular
varnish | stains according to house collection**table top**wood core plywood
varnish | stains | wood veneer | HPL
according to house collection**edges**solid beech edge
varnish | stains according to house collection**price**

from EUR 614,-

KANTEN . EDGESKantenprofil 29
edge profile 29Ein Aufriss des Kantenaufbaus befindet sich auf Seite 273.
A layout of the edge configuration is presented on page 273.**GRÖSSEN . SIZES**quadratisch
square

800 x 800 mm

rechteckig
rectangular1000 - 1800 mm x 600 mm
1000 - 1800 mm x 700 mm
1000 - 1800 mm x 800 mm
1000 - 1800 mm x 900 mm

262



285



279



291



281

TISCH 411 . TABLE 411



Tischplatte mit Holzfurnier | Gestell Buche massiv,
gebeizt
table top with wood veneer | stained solid wooden
frame

AUSFÜHRUNG . DESIGN

Unterschiedliche Farben, Dekore, Materialien und Veredelungen bieten individuelle Gestaltungsmöglichkeiten.

The choice of different colors, decors, materials and finishings guarantees individual freedom when it comes to design options.

Tischhöhe

740 mm

Gestell

Buche massiv, Quadratstollen
Lack | Beize gemäß Hauskollektion

Tischplatte

Tischlerplatte mit Spandeck
Lack | Beize | Holzfurnier | HPL
gemäß Hauskollektion

Tischkante

Buche Vollholz
Lack | Beize gemäß Hauskollektion

Preis

ab EUR 614,-

table height

740 mm

frame

solid beech, square
varnish | stains according to house collection

table top

wood core plywood
varnish | stains | wood veneer | HPL
according to house collection

edges

solid beech edge
varnish | stains according to house collection

price

from EUR 614,-

KANTEN . EDGES

Kantenprofil 29
edge profile 29

Ein Aufriss des Kantenaufbaus befindet sich auf Seite 273.
A layout of the edge configuration is presented on page 273.

GRÖSSEN . SIZES

quadratisch
square

800 x 800 mm



rechteckig
rectangular

1000 - 1800 mm x 600 mm
1000 - 1800 mm x 700 mm
1000 - 1800 mm x 800 mm
1000 - 1800 mm x 900 mm



262



285



279



291



281

STEHTISCH 412 . STAND-UP TABLE 412



Tischplatte mit Holzfurnier | Gestell Buche massiv,
gebeizt
table top with wood veneer | stained frame

AUSFÜHRUNG . DESIGN

Verschiedene Tischformen, Tischgrößen und Plattenmaterialien, umfangreiches Zubehör sowie eine große Auswahl an Farben und Dekoren ermöglichen die Anpassung an individuelle Raumkonzepte.

Various shapes and sizes of tables, board materials, accessories as well as a large variety of colors and decors allow the adjustment to individual room designs.

Tischhöhe

1100 mm

Gestell

Buche massiv, Rechteckstollen
Lack | Beize gemäß Hauskollektion
Fußstütze Edelstahl

Tischplatte

Tischlerplatte mit Spandeck
Lack | Beize | Holzfurnier | HPL
gemäß Hauskollektion

Tischkante

Buche Vollholz
Lack | Beize gemäß Hauskollektion

Preis

ab EUR 869,-

table height

1100 mm

frame

solid beech, rectangular
varnish | stains according to house collection

table top

wood core plywood
varnish | stains | wood veneer | HPL
according to house collection

edges

solid beech edge
varnish | stains according to house collection

price

from EUR 869,-

KANTEN . EDGES

Kantenprofile 29
edge profile 29

Ein Aufriss des Kantenaufbaus befindet sich auf Seite 273.
A layout of the edge configuration is presented on page 273.

FUSSSTÜTZE . FOOT REST GRÖSSEN . SIZES

Edelstahl
stainless steel



rechteckig
rectangular

1000 - 1800 mm x 600 mm
1000 - 1800 mm x 700 mm
1000 - 1800 mm x 800 mm
1000 - 1800 mm x 900 mm



262



285



279



291



281

STAND UP



1 Vollkernplatte schwarz | Gestell verchromt
solid core panel, black | chrome-plated frame





1



STAND UP

stand up ist der einzige klappbare Stehtisch, dessen Design so herausragend ist, dass er sich nicht unter einer Tischdecke oder Husse verstecken muss. Das Dreibein-Gestell des klappbaren Stehtischs bietet eine hohe Standfestigkeit und benötigt aufgrund der engen Staffelnabstände wenig Platz bei der Lagerung. Die Tischplatten sind aus HPL und somit kratzfest, lichtecht sowie gegen Zigarettenglut beständig.

stand up flips down for easy, space-saving storage and impresses with an outstanding design that makes hiding away under any tablecloth or cover redundant. Its tripod frame offers exceptional stability. Tabletops are made of high-pressure laminate and guarantee resistance to scuffing, UV rays, and cigarette burns.

STAND UP



1

-
- 1 Klappmechanismus, enge Staffelung
folding mechanism, tight staggering
 - 2 Vollkernplatte weiß | Gestell verchromt
solid core panel, white | chrome-plated frame

AUSFÜHRUNG . DESIGN

Unterschiedliche Farben, Dekore und Materialien bieten individuelle Gestaltungsmöglichkeiten.

The choice of different colors, decors and materials guarantees individual freedom when it comes to design options.

STAND UP

**Tischhöhe**

1087 - 1100 mm

Gestell

Stahlrohr
verchromt | polyamidbeschichtet
gemäß Hauskollektion

Tischplatte

Spanplatte | Schichtholzplatte | Vollkernplatte
HPL gemäß Hauskollektion

Tischkante

ABS-Kante | Buche-Umleimer
Vollkernplatte mit schwarzer Kante

Preis

ab EUR 400,-

table height

1087 - 1100 mm

frame

steel tube
chrome-plated | polyamide-coated
according to house collection

table top

chipboard | laminated wood | solid core panel
HPL according to house collection

table edge

ABS edge | beech edging
solid core panel: black edge

price

from EUR 400,-

KANTEN . EDGES

Kantenprofile 10 | 30 | 32
edge profiles 10 | 30 | 32

Ein Aufriss des Kantenaufbaus befindet sich auf Seite 273.
A layout of the edge configuration is presented on page 273.

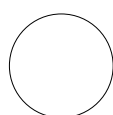
GRÖSSEN . SIZES

rund
rund
Ø 700 mm



triagonal
triangular
r = 700 mm

DETAIL . DETAIL

Klappmechanismus
folding mechanism



262



285



279



291



281

2960 · 2970 | 2961 · 2971

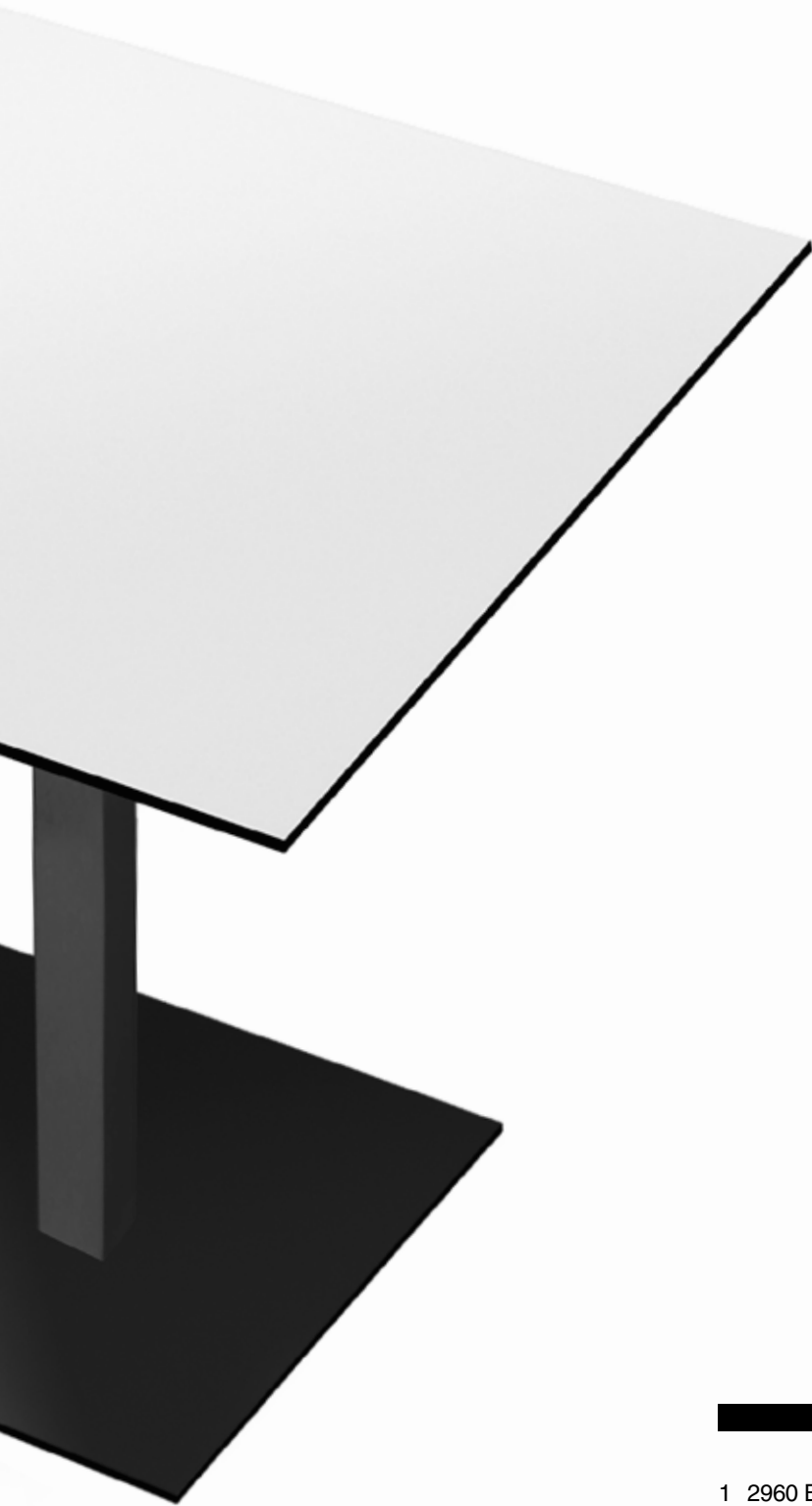

-
- 1 2960 Bistrotisch | weiÙe HPL-Vollkernplatte, Gestell weiÙ pulverbeschichtet · bistro table | white solid core panel, white powder-coated frame
 - 2 2971 Stehtisch | weiÙe HPL-Vollkernplatte, Gestell schwarz pulverbeschichtet · stand-up table | white solid core panel, black powder-coated frame



1



2

2960 | 2961 . 2970 | 2971

Ob rund mit rundem Säulengestell oder quadratisch mit einer Mittelsäule aus 60 x 60 mm starkem Stahlrohr – die Bistrotische 2960/2970 und die Stehtische 2961/2971 sind immer eine gute Wahl. Das Gestell kann in drei verschiedenen RAL-Farben beschichtet werden. Für die runde bzw. quadratische Tischplatte stehen eine mit HPL belegte, 28 mm starke Spanplatte oder eine nur 10 mm dünne Vollkernplatte zur Auswahl, jeweils in verschiedenen Farben und Dekoren.



Designed either with a round-shaped or square-shaped pedestal base made of 60 x 60 mm solid steel tube, the bistro tables 2960/2970 and the stand-up tables 2961/2971 are the perfect choice for different settings. The frame may be coated with three different RAL colors. For the round or square table top you may choose between 28 mm strong chipboard covered with HPL or a 10 mm thin solid core panel, each of which is available in numerous colors and decors.

2960 | 2961



-
- 1 2960 | weiße HPL-Vollkernplatte, Gestell weiß pulverbeschichtet · white HPL solid core panel, white powder-coated frame
 - 2 2961 | Tischplatte mit weißem HPL belegt, Gestell weiß pulverbeschichtet · table top with white HPL cover, white powder-coated frame

AUSFÜHRUNG . DESIGN

Unterschiedliche Farben und Dekore bieten individuelle Gestaltungsmöglichkeiten.

The choice of different colors and decors guarantees individual freedom when it comes to design options.

2960 | 2961

Tischhöhe

720 - 740 mm | 1080 - 1100 mm

GestellRundstahlrohr
pulverbeschichtet weiß | schwarz | silber**Bodenplatte**

Stahl, pulverbeschichtet

DeckplatteStahlblech
pulverbeschichtet weiß | schwarz | silber**Tischplatte**Schichtholzplatte | Vollkernplatte
HPL gemäß Hauskollektion**Tischkante**

ABS-Kante | Vollkernplatte mit schwarzer Kante

Preis

ab EUR 385,-

table height

720 - 740 mm | 1080 - 1100 mm

frameround steel tube
powder-coated white | black | silver**base plate**

steel, powder-coated

cover platesteel sheet
powder-coated white | black | silver**table top**laminated wood | solid core panel
HPL according to house collection**edges**

ABS edge | solid core panel with black edge

price

from EUR 385,-

KANTEN . EDGESKantenprofile 30 | 2030
edge profiles 30 | 2030Ein Aufriss des Kantenaufbaus befindet sich auf Seite 273.
A layout of the edge configuration is presented on page 273.**GRÖSSEN . SIZES**rund
round

Ø 600 - 1000 mm



262



285



279



291



281

2970 | 2971



1



2

-
- 1 2970 | Tischplatte mit weißem HPL belegt, Gestell schwarz pulverbeschichtet · table top with white HPL cover, black powder-coated frame
 - 2 2971 | weiße HPL-Vollkernplatte, Gestell schwarz pulverbeschichtet · white HPL solid core panel, black powder-coated frame

AUSFÜHRUNG . DESIGN

Verschiedene Tischgrößen und Plattenmaterialien sowie eine große Auswahl an Farben und Dekoren ermöglichen die Anpassung an individuelle Raumkonzepte.

Various sizes of tables, board materials as well as a large variety of colors and decors allow the adjustment to individual room designs.

2970 | 2971

Tischhöhe

720 - 740 mm | 1080 - 1100 mm

GestellVierkantstahlrohr
pulverbeschichtet weiß | schwarz | silber**Bodenplatte**

Stahl, pulverbeschichtet

DeckplatteStahlblech
pulverbeschichtet weiß | schwarz | silber**Tischplatte**Schichtholzplatte | Vollkernplatte
HPL gemäß Hauskollektion**Tischkante**

ABS-Kante | Vollkernplatte mit schwarzer Kante

Preis

ab EUR 302,-

table height

720 - 740 mm | 1080 - 1100 mm

framesquare steel tube
powder-coated white | black | silver**base plate**

steel, powder-coated

cover platesteel sheet
powder-coated white | black | silver**table top**laminated wood | solid core panel
HPL according to house collection**edges**

ABS edge | solid core panel with black edge

price

from EUR 302,-

KANTEN . EDGESKantenprofile 30 | 2030
edge profiles 30 | 2030Ein Aufriss des Kantenaufbaus befindet sich auf Seite 273.
A layout of the edge configuration is presented on page 273.**GRÖSSEN . SIZES**quadratisch
square500 x 500 mm
600 x 600 mm
700 x 700 mm
800 x 800 mm
900 x 900 mm

262



285



279



291



281

LIMES



1 Bank, Eiche furniert
bench, oak veneer

2 Tisch, Eiche furniert
table, oak veneer



LIMES

Limes kennzeichnet eine Reihe von Brückentischen und Bänken in zeitloser Eleganz. Dank der verschiedenen Größen, Oberflächen und Farben lässt sich Limes flexibel in vielen Raumsituationen einsetzen. Die Limes-Bänke können mit Polstern ausgestattet werden und bilden als Sitzlandschaft ein individuelles Highlight in Empfangs- und Wartebereichen.



Limes is the name of a series of panel end tables and benches designed for timeless elegance. Available in various sizes with different finishes and colors, Limes can be used flexibly in a wide range of interior settings. The Limes benches can be fitted with comfortable upholstery to create a unique, self-contained seating ensemble in reception and waiting areas.

LIMES BANK . BENCH



Eiche, furniert, ungepolstert
oak veneer, without upholstery

AUSFÜHRUNG . DESIGN

Die Tische der Limes Kollektion sind in vielen verschiedenen Farben, Dekoren, Materialien und Veredelungen erhältlich.

The tables of the Limes line are available in numerous colors, decors, materials and finishings.

LIMES

Höhe
450 mm

Trägerplatte
Spanplatte

Ausführung
Buche | Eiche | Nussbaum furniert
decklackiert nach RAL
mit HPL belegt gemäß Hauskollektion

Kantenprofil
ABS-Umleimer | Massivholzkante

Eckverbindung
auf Gehrung verleimt | stumpf verleimt

Preis
ab EUR 608,-

ECKVERBINDUNG . CORNER JOINT



auf Gehrung verleimt stumpf verleimt
mitred and glued glued blunt

GRÖSSEN . SIZES



rechteckig
rectangular

1200-2000 mm x 400 mm
1200-2000 mm x 600 mm
1300-2000 mm x 800 mm

height
450 mm

support plate
raw particleboard

design
beech | oak | walnut veneer
varnish according to RAL
HPL according to house collection

edge profile
ABS edging | solid wood edge

corner joint
mitred and glued | glued blunt

price
from EUR 608,-



262



285



279



291



281

LIMES SITZLANDSCHAFT . SEATING ENSEMBLE



HPL weiß | jeweils 1 Sitzpolster klein und groß
white HPL | 1 small and 1 large seat upholstery

AUSFÜHRUNG . DESIGN

Unterschiedliche Farben, Dekore, Materialien und Veredelungen bieten individuelle Gestaltungsmöglichkeiten.

The choice of different colors, decors, materials and finishings guarantee individual freedom when it comes to design options.

LIMES

Höhe

450 mm

Trägerplatte

Spanplatte

Ausführung

Buche | Eiche | Nussbaum furniert
decklackiert nach RAL
mit HPL belegt gemäß Hauskollektion

Polster

Verschiedene Größen
diverse Stoffe, variable Anordnung

Kantenprofil

ABS-Umleimer | Massivholzkante

Eckverbindung

auf Gehrung verleimt | stumpf verleimt

Preis

ab EUR 810,-

height

450 mm

support plate

raw particleboard

design

beech | oak | walnut veneer
varnish according to RAL
HPL according to house collection

upholstery

different sizes
diverse fabrics, variable configuration

edge profile

ABS edging | solid wood edge

corner joint

mitred and glued | glued blunt

price

from EUR 810,-

POLSTER . UPHOLSTERY

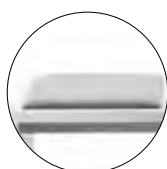

Sitzpolster groß

seat upholstery large

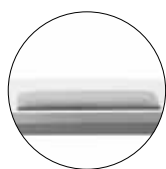

Sitzpolster klein

seat upholstery small

ECKVERBINDUNG . CORNER JOINT



auf Gehrung verleimt

mitred and glued



stumpf verleimt

glued blunt

GRÖSSEN . SIZES



rechteckig

rectangular

1200-2000 mm x 400 mm

1200-2000 mm x 600 mm

1300-2000 mm x 800 mm

LIMES TISCH . TABLE



Eiche furniert · oak veneer

AUSFÜHRUNG . DESIGN

Verschiedene Tischgrößen und Plattenmaterialien sowie eine große Auswahl an Farben und Dekoren ermöglichen die Anpassung an individuelle Raumkonzepte.

Various sizes of tables, board materials, as well as a large variety of colors and decors allow the adjustment to individual room designs.

LIMES

Höhe

750 mm

Trägerplatte

Spanplatte

Ausführung

Buche | Eiche | Nussbaum furniert
decklackiert nach RAL
mit HPL belegt gemäß Hauskollektion

Kantenprofil

ABS-Umleimer | Massivholzkante

Eckverbindung

auf Gehrung verleimt | stumpf verleimt

Preis

ab EUR 608,-

ECKVERBINDUNG . CORNER JOINT

auf Gehrung verleimt
mitred and glued



stumpf verleimt
glued blunt

GRÖSSEN . SIZES

rechteckig
rectangular

1200-2000 mm x 400 mm

1200-2000 mm x 600 mm

1200-2000 mm x 800 mm

height

750 mm

support plate

raw particleboard

design

beech | oak | walnut veneer
varnish according to RAL
HPL according to house collection

edge profile

ABS edging | solid wood edge

corner joint

mitred and glued | glued blunt

price

from EUR 608,-



262



285



279



291



281

LIMES HOCHTISCH . HIGH-LEVEL TABLE



HPL weiß, mit optionaler Fußstütze
white HPL, with optional foot rest

AUSFÜHRUNG . DESIGN

Unterschiedliche Farben, Dekore, Materialien und Veredelungen bieten individuelle Gestaltungsmöglichkeiten.

The choice of different colors, decors, materials and finishings guarantee individual freedom when it comes to design options.

LIMES

Höhe

1100 mm

Trägerplatte

Spanplatte

Ausführung

Buche | Eiche | Nussbaum furniert
decklackiert nach RAL
mit HPL belegt gemäß Hauskollektion

Kantenprofil

ABS-Umleimer | Massivholzkante

Eckverbindung

auf Gehrung verleimt | stumpf verleimt

Fußstütze

Edelstahl, gegen Aufpreis

Preis

ab EUR 708,-

height

1100 mm

support plate

raw particleboard

design

beech | oak | walnut veneer
varnish according to RAL
HPL according to house collection

edge profile

ABS edging | solid wood edge

corner joint

mitred and glued | glued blunt

foot rest

stainless steel, for extra charge

price

from EUR 708,-

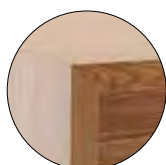
ECKVERBINDUNG . CORNER JOINT

auf Gehrung verleimt
mitred and glued



stumpf verleimt
glued blunt

FUSSSTÜTZE . FOOT REST

Edelstahl
stainless steel

GRÖSSEN . SIZES

rechteckig
rectangular

1200-2000 mm x 400 mm
1200-2000 mm x 600 mm
1200-2000 mm x 800 mm



262



285



279



291



281

ZUBEHÖR SITZMÖBEL

ACCESSORIES SEATING FURNITURE



ARKETTO



Polyamidgleiter
polyamide
gliders

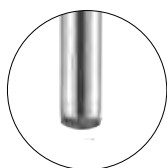

Filzgleiter
felt gliders



Flüstergleiter
silent glider
pads



plnr-007
Platznummer
seat number

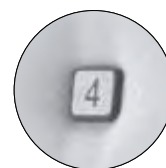

plnr-008
Platznummer
seat number



rsch-150
Reihenschild
row number



scpl-150
Schreibrätablet
writing tablet



002
Transportkarren
trolley



005
Transportkarren
trolley



009
Transportkarren
trolley



ATICON



Polyamidgleiter
polyamide
gliders

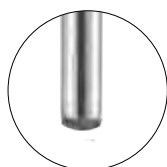

Filzgleiter
felt gliders

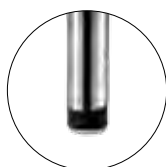

Flüstergleiter
silent glider
pads



plnr-007
Platznummer
seat number

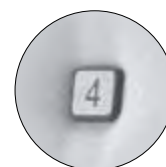

plnr-008
Platznummer
seat number



plha-001 | plnr-004
Platznummer
seat number



rsch-003
Reihenschild
row number

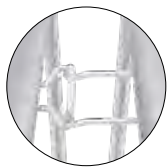

reve-001
Auszieh-
Reihenverbindung
extractable ganging device



002
Transportkarren
trolley



005
Transportkarren
trolley



009
Transportkarren
trolley



ATLANTA 55 | 66 | 67



Polyamidgleiter
atlanta 55
polyamide
gliders

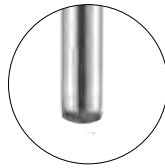

Filzgleiter
atlanta 55
felt gliders



Flüstergleiter
atlanta 55
silent glider
pads

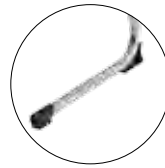

Polyamidgleiter
atlanta 66 | 67
polyamide
gliders

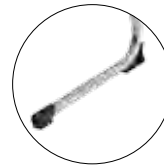

Filzgleiter
atlanta 66 | 67
felt gliders



scpl-002/2
Schreibratlar
atlanta 55
writing tablet



plha-001 | plnr-004
Platznummer
atlanta 55 | 66 | 67
seat number



rsch-003
Reihenschild
atlanta 55
row number

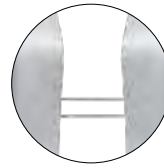

reve-001
Auszieh-Reihenverbindung
atlanta 55
extractable ganging device



plnr-007
Platznummer
atlanta 55 | 66 | 67
seat number

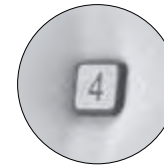

plnr-008
Platznummer
atlanta 55 | 66 | 67
seat number



plnr-001
Platznummer
atlanta 55 | 66 | 67
seat number



002
Transportkarren
atlanta 55
trolley



005
Transportkarren
atlanta 55
trolley



buab-005
Buchablage
atlanta 55
book shelf

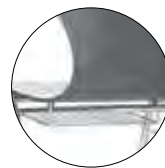

buab-006
Buchablage
atlanta 55
book shelf



ATLANTA 450 | ATLANTA 456



Polyamidgleiter
polyamide
gliders

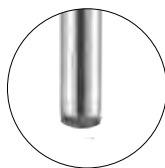

Filzgleiter
felt gliders



Flüstergleiter
silent glider
pads



plnr-007
Platznummer
(nur atlanta 450)
seat number
(only atlanta 450)

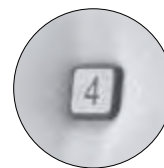

plnr-008
Platznummer
atlanta 450
seat number



rsch-003
Reihenschild
row number



Krallen-
Reihenverbindung
claw
ganging device



"Elegance"
Reihenverbindung
"elegance"
ganging device



scpl-450
Schreibratlar
atlanta 450
writing tablet



002
Transportkarren
trolley



005
Transportkarren
trolley

ZUBEHÖR SITZMÖBEL

ACCESSORIES SEATING FURNITURE



BONNIE & CLYDE



Polyamidgleiter
polyamide
gliders



Filzgleiter
felt gliders



plnr-007
Platznummer
seat number

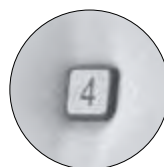

plnr-008
Platznummer
seat number



fortlaufende
Nummerierung
consecutive numbering



rsch
Reihenschild
row numbering



Kompakt-
Reihenverbindung
compact
ganging device



buab-250
Buchablage
book shelf



Kniebank
kneel rest



007
Transportkarren
trolley



ELENA



Polyamidgleiter
polyamide gliders



Filzgleiter
felt gliders



plha-001 | plnr-004
Platznummer
seat number



plnr-003
Platznummer
seat number



rsch-003
Reihenschild
row numbering



buab-002
Buchablage
book shelf

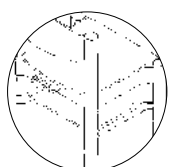

buab-003
Buchablage
book shelf



reve-001
Auszieh-Reihen-
verbindung
extractable
ganging device



Kniebank
kneel rest



002
Transportkarren
trolley



005
Transportkarren
trolley



ELESS



Reihenverbindung | Gleiter
ganging device |
gliders

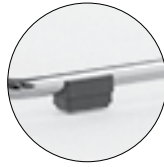

Polyamid-/Filzgleiter
polyamide/felt
gliders



plnr-007
Platznummer
seat number

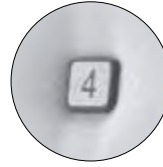

plnr-008
Platznummer
seat number



rsch-010
Reihenschild
row number



scpl-420
Schreibtislar
writing tablet

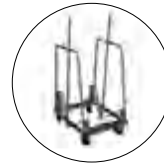

011
Transportkarren
trolley

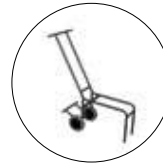

012
Transportkarren
trolley



GARCIA



Polyamidgleiter
polyamide
gliders

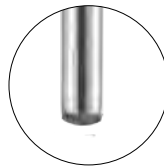

Filzgleiter
felt gliders

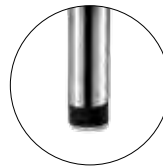

Flüstergleiter
silent glider
pads



plnr-007
Platznummer
seat number

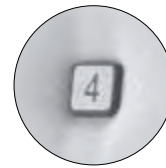

plnr-008
Platznummer
seat number



fortlaufende
Nummerierung
consecutive numbering



rsch-003
Reihenschild
row number



scpl-200
Schreibtislar
fahrbar
movable
writing tablet



scpl-201
Schreibtislar
hochklappbar
hinged writing tablet

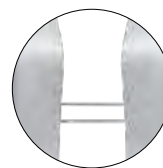

reve-001
Auszieh-
Reihenverbindung
extractable
ganging device



Klappbügel-
Reihenverbindung
hinged clamp
ganging device



007
Transportkarren
trolley



KARLSSON



Polyamid-/Filz-
gleiter
polyamide/felt
gliders



Polyamidgleiter
polyamide
gliders



Filzgleiter
felt gliders



Metallkappen-
gleiter
gliders with metal
caps

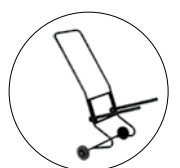

007
Transportkarren
trolley



KOLLEKTION.58 CONTRACT CHAIR

ZUBEHÖR SITZMÖBEL

ACCESSORIES SEATING FURNITURE

KRISCHANITZ KOLLEKTION BENTWOOD



Polyamidgleiter
polyamide gliders



Filzgleiter
felt gliders

LI-LITH



Polyamidgleiter
polyamide gliders



Filzgleiter
felt gliders

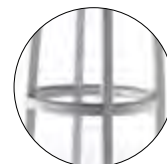

Metallschutz
Fußabstellring
metal cover
footrest

LISTO



Polyamidgleiter
polyamide
gliders

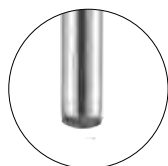

Filzgleiter
felt gliders

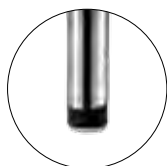

Flüstergleiter
silent glider
pads



pInr-007
Platznummer
seat number

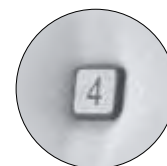

pInr-008
Platznummer
seat number



fortlaufende
Nummerierung
consecutive
numbering



rsch
Reihenschild
row number



rsch-003
Reihenschild
row number



scpl-211
Schreibtislar fahrbar
movable
writing tablet

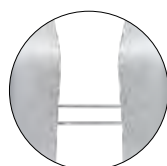

reve-001
Auszieh-Reihen-
verbindung
extractable
ganging device



Klappbügel-
Reihenverbindung
hinged clamp
ganging device



002
Transportkarren
trolley



007
Transportkarren
trolley



LOGOCHAIR



Polyamidgleiter
polyamide
gliders



Filzgleiter
felt gliders



Flüstergleiter
silent glider
pads



plnr-007
Platznummer
seat number

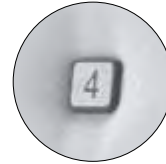

plnr-008
Platznummer
seat number



rsch-009
Platznummer
seat number



scpl-495
Schreibratler
writing tablet



Reihenverbindung
ganging device



Reihenverbindung
paniksicher
anti-panic
ganging device



Auszieh-Reihenver-
bindung (Sessel),
optional paniksicher
extractable ganging
device (armchairs),
optional anti-panic
feature



002
Transportkarren
trolley



005
Transportkarren
trolley



PAN



Polyamidgleiter
polyamide
gliders



Filzgleiter
felt gliders



plnr-007
Platznummer
seat number

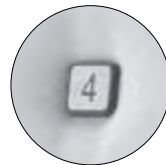

plnr-008
Platznummer
seat number

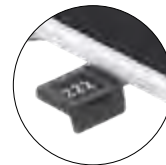

plha-001 | plnr-004
Platznummer
seat number



rsch-003
Reihenschild
row numbering



reve-001
Auszieh-
Reihenverbindung
extractable
ganging device



002
Transportkarren
trolley



007
Transportkarren
trolley

ZUBEHÖR SITZMÖBEL

ACCESSORIES SEATING FURNITURE



RONDO



Polyamidgleiter
polyamide
gliders



Filzgleiter
felt gliders

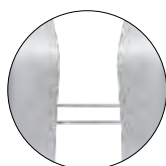

reve-001
Auszieh-Reihen-
verbindung
extractable
ganging device



Nackenkissen
(modellabhängig)
neck cushion
(depending on
model)

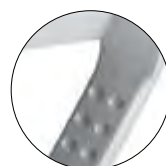

Armlehnen-
therapiebohrung
indentations



Schaukelkufen
rocking skids



Schichtholz-
Griffbügel
laminated wood
handle



Bugholz-
Griffbügel
bentwood
handle



AUFR-283
Griffmulde
wood
handle



002
Transportkarren
trolley



007
Transportkarren
trolley



STRESEMANN



Polyamidgleiter
polyamide gliders



Filzgleiter
felt gliders



TENDO



Filzgleiter
felt gliders



007
Transportkarren
trolley



ULTIMO



Rückenkissen
back cushions



WIENER FAUTEUIL



Polyamidgleiter
polyamide gliders



Filzgleiter
felt gliders

ZUBEHÖR TISCHE

ACCESSORIES TABLES



206 · 207



Polyamidgleiter
polyamide
gliders



Polyamidgleiter
polyamide
gliders

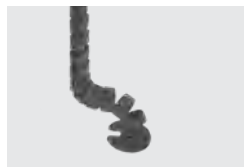

Kabelkanal
cable duct



Netbox
net box



410 · 411 · 412



Polyamidgleiter
polyamide
gliders



Filzgleiter
felt gliders

ZUBEHÖR TISCHE

ACCESSORIES TABLES



DELTA 100 | DELTA 110



**Polyamidgleiter
Filzgleiter**
polyamide gliders
felt gliders

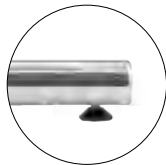

**Höhenverstellbare Gleiter
Filz/Polyamid**
height-adjustable gliders
felt/polyamide



**001
Transportwagen**
trolley



Einhängeplatte Rechteck
intermediate table top rectangular



Varianten
variants



Kabelkanal
cable duct

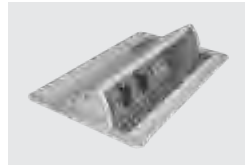

Netbox
netbox



Sichtblende
screen



LIMES



Polyamidgleiter
polyamide
gliders



Filzgleiter
felt glider



**Fußstütze
Edelstahl**
stainless steel
footrest



LOGOTABLE



Kabelkanal
cable duct

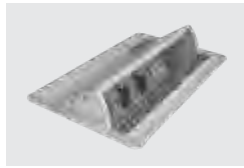

Netbox
netbox



TABULA LIGHT



Polyamidgleiter
polyamide
gliders



Filzgleiter
felt gliders

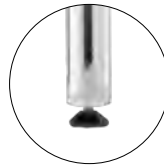

Höhenverstellbare (Gelenk-)gleiter
Filz/Polyamid
height-adjustable (joint) gliders
felt/polyamide



STAND UP

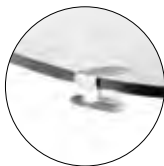

Tischhaken
table hook



Polyamidgleiter
polyamide
gliders



003
Tischwagen
table trolley

ZUBEHÖR TISCHE

ACCESSORIES TABLES



SYSTEM 24



Rolle
castor

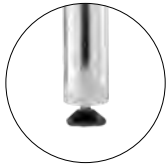

Höhenverstellbare (Gelenk-)gleiter
Filz/Polyamid
height-adjustable (joint) gliders
felt/polyamide



Tischwagen 002
table trolley 002



Tischwagen 001
table trolley 001



Connector
connector

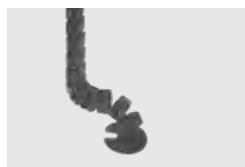

Kabelkanal
cable duct



Netbox
net box



Sichtblendenbefestigung
"Design"
screen fixation "design"



Sichtblendenbefestigung
"Classic"
screen fixation "classic"



Einhängeplatte
gerundet
rounded table top



Einhängeplatte
Dreieck
triangular table top



Einhängeplatte
Rechteck
table top rectangular



Varianten
variants

KANTENPROFILE

EDGE PROFILES

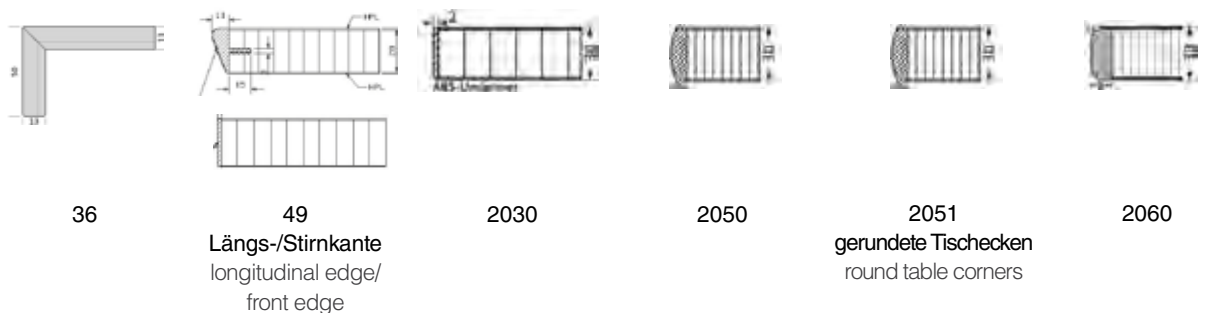
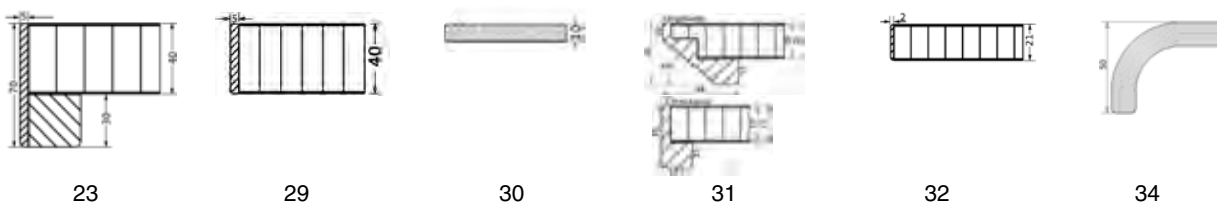
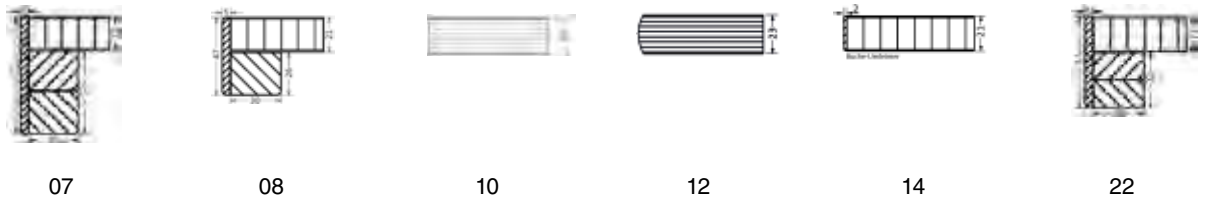
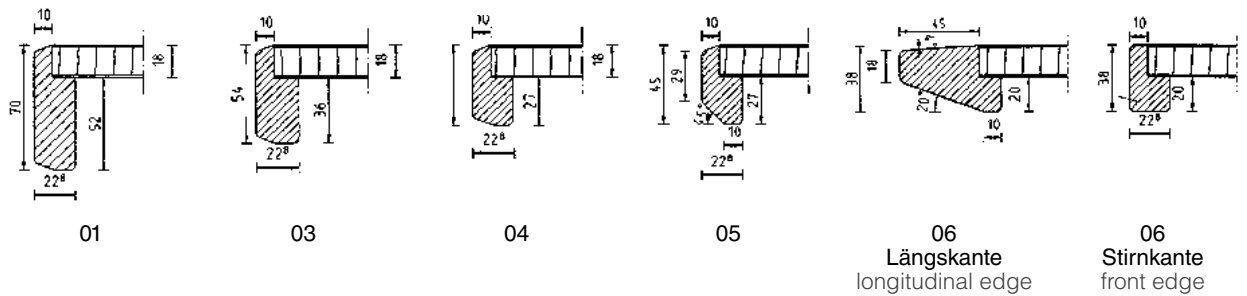

INDIV

IDUAL

ITÄT

***HANDWERKSKUNST &
MATERIALKUNDE***

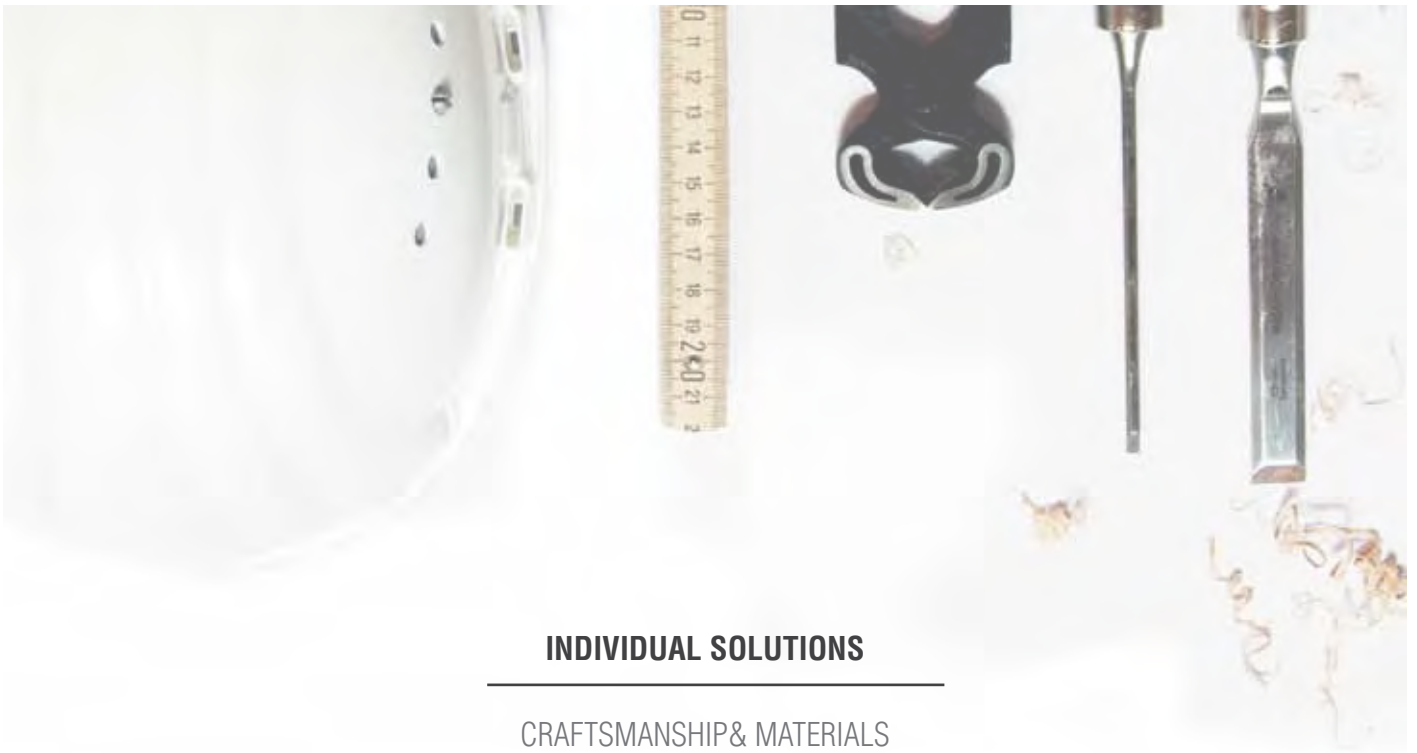

INDIVIDUAL SOLUTIONS

CRAFTSMANSHIP & MATERIALS







MASSIVHOLZ IST EIN LANGLEBIGER UND NACHWACHSENDER ROHSTOFF. DIESES MODERNE MATERIAL MIT NATÜRLICHER AUSSTRAHLUNG SORGT FÜR EIN ANGENEHMES RAUMKLIMA UND TRÄGT SO ZUM WOHLBEFINDEN BEI. SEINE INDIVIDUELLE OBERFLÄCHE FÜHLT SICH WARM UND SEIDIG AN, MAN SPÜRT EINE HAPTİK, DIE VON KEINEM ANDEREN MATERIAL ERREICHT WIRD. HOLZ IST EIN HOCHWERTIGES NATURMATERIAL, STETS VERSCHIEDEN UND INDIVIDUELL. KEINES GLEICHT DEM ANDEREN. UNREGELMÄSSIGKEITEN IN FARBE UND STRUKTUR SIND TYPISCHE QUALITÄTSMERKMALE UND ERGEBEN IN DER WIRKUNG EIN AUSSERGEWÖHNLICHES ERSCHEINUNGSBILD.

Solid wood is a durable and renewable resource. This modern material with its natural appearance ensures a pleasant indoor climate and thus contributes considerably to our well being. Its individual surface feels silky and warm, its haptics is unmatched by any other material. Wood is a precious natural material, constantly different and individual. None is alike. Variations in color and texture are quality characteristics and constitute an extraordinary appearance.



Buche
beech



Eiche
oak



Ahorn
maple

Des Weiteren auf Anfrage erhältlich: Massivholz aus Walnuss, Esche, Lärche u. v. m.
Further options of solid wood such as walnut, ash or larch are available upon request.

MASSIVHOLZ | SOLID WOOD

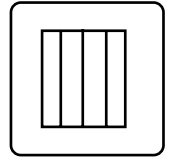



SCHICHTSTOFFOBERFLÄCHEN | LAMINATE SURFACES



SCHICHTSTOFFOBERFLÄCHEN BEDÜRFFEN AUFGRUND IHRER
WIDERSTANDSFÄHIGEN UND HYGIENISCHEN, DICHTEN
OBERFLÄCHE KEINER BESONDEREN PFLEGE. SIE SIND IM
ALLGEMEINEN LEICHT ZU REINIGEN, DIES GILT IN DER REGEL
AUCH FÜR STRUKTURIERTE OBERFLÄCHEN.

Laminate surfaces require no special care due to their impact resistant and hygienic, dense surface. Generally, they are easy to clean, this applies to structured surfaces as well.







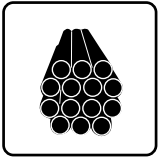

GESTELLFARBEN | FRAME COLORS



GANZ IM ZEICHEN DER VIELFALT STEHEN
 DIE MÖGLICHKEITEN BEI DER AUSWAHL DER
 GESTELLFARBEN. HIER SIND DER KREATIVITÄT KEINE
 GRENZEN GESETZT, DIE OBERFLÄCHEN DER GESTELLE
 GEBEN INDIVIDUELLES AUSSEHEN UND SETZEN
 UNTERSCHIEDLICHSTE AKZENTE, UM RAUMKONZEPTE
 AUFLEBEN ZU LASSEN.

When it comes to the diversity of frame finishes, the possibilities are almost endless, without any creative boundaries. Frame finishes add an individual touch and emphasize the features of specific architectural and spatial concepts.



**Chrom
glänzend**
polished
chrome



aluminiumsilber*
ähnl. **matchrom**
similar to matte chrome
aluminum silver*



**Edelstahl
geschliffen**
brushed
stainless steel



titansilber
ähnl. **RAL7001**
similar to RAL7001
titanium silver

**Stahl pulverbeschichtet nach
unserer RAL Hauskollektion**
steel powder-coated according to
our RAL house collection

weitere Farben erhältlich
further colors available



verkehrsweiß*
ähnl. **RAL 9016**
similar to RAL 9016
traffic white



schwarz*
ähnl. **RAL 9005**
similar to RAL 9005
black





Handwritten label on pink container: 5/4

Handwritten label on blue container: 401598
Handwritten symbol: (M)

Handwritten label on orange container: 0554263
Handwritten label on orange container: 585V04

Handwritten label on light purple container: 401598
Handwritten label on light purple container: 585V04
Handwritten symbol: (M)

Handwritten label on orange container: 401598
Handwritten symbol: (M)
Handwritten label on orange container: 1+15

Handwritten label on pink container: 0554263
Handwritten label on pink container: 585V04

Handwritten label on white container: 401598



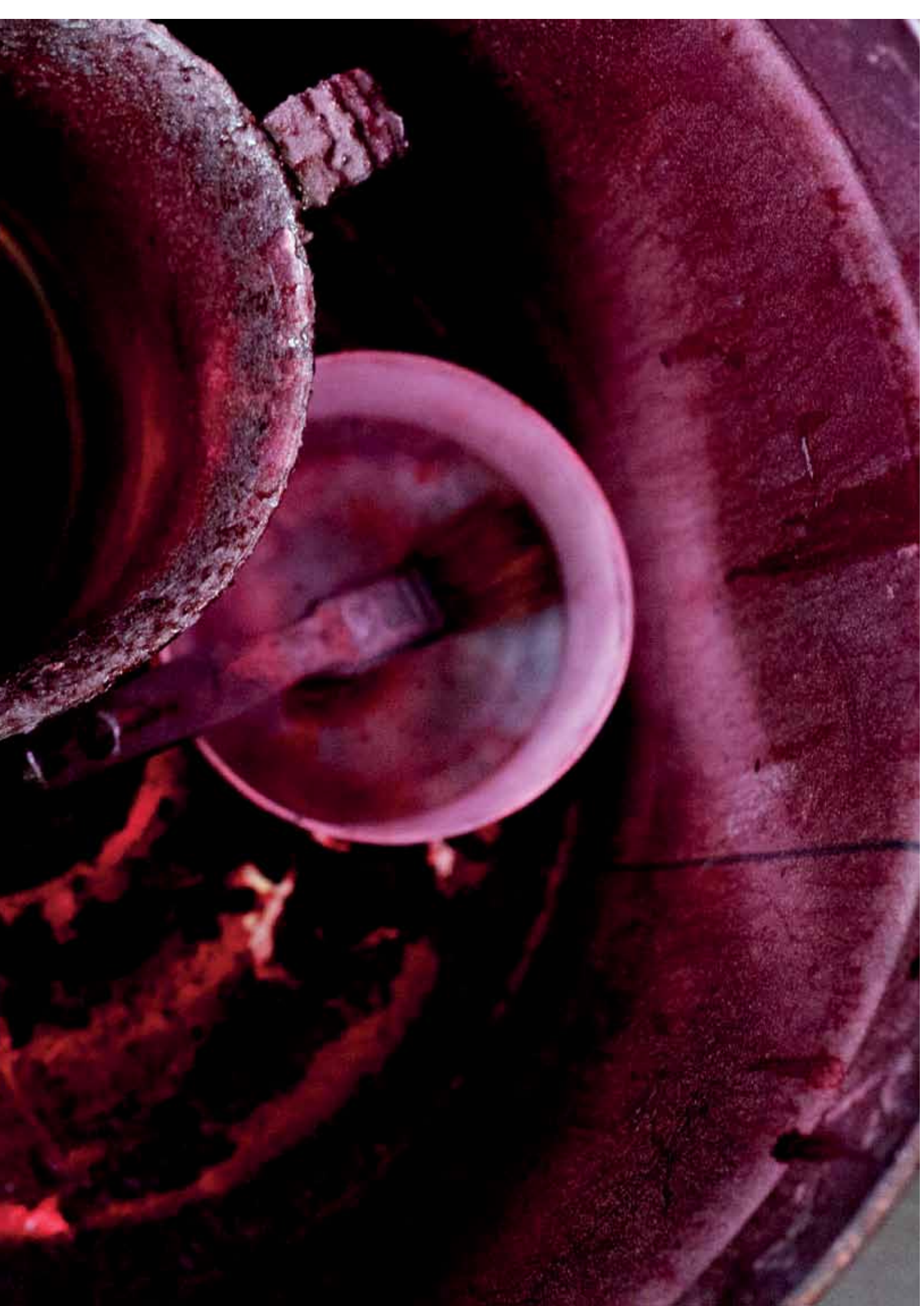

FÜR ALLE HOLZBEREICHEN STEHEN ZAHLREICHE FARBEN ZUR AUSWAHL. SÄMTLICHE BEIZTÖNE SIND FARBLICH AUF UNSERE SCHICHTSTOFFBEREICHENKOLLEKTION ABGESTIMMT UND KÖNNEN SOWOHL FÜR FURNIERTE TISCHPLATTEN ALS AUCH FÜR DIE HOLZTEILE VON STÜHLEN AUSGEWÄHLT WERDEN.

Various colors are available for all wood surfaces. All stains are color-coordinated with our laminate surface collection and can be selected both for veneered table tops as well as wooden elements of chairs.



natur gebeizt
naturally stained



farbig gebeizt
stained in color



decklackiert
varnished

BEIZEN UND LACKE | STAINS & VARNISHES







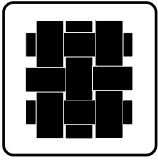

STOFFE | FABRICS

STOFFKOLLEKTION | HOUSE COLLECTION



VON WOLLE UND TREVIRA CS ÜBER VELOURS, MIKROFASER,
KUNSTLEDER UND LEDER BIS ZU HYGIENISCHEN,
PFLEGELEICHTEN STOFFEN FÜR DEN CAREBEREICH – UNSERE
HAUSKOLLEKTION BIETET DIE PASSENDEN STOFFE FÜR
IHRE INDIVIDUELLEN BEDÜRFNISSE. SIE HABEN DIE „QUAL
DER WAHL“ UND KÖNNEN AUS ERLESENEN PRODUKTEN
RENOMMIERTER HERSTELLER WÄHLEN.

From wool and Trevira CS over velours, microfiber and genuine leather up to
hygienic, easy-care fabrics for the care sector, our house collection offers you the
perfect fabric for your individual needs. The choice is yours, feel free to select from
a wide product range by renowned premium manufacturers.







I N D E X

PRODUCT OVERVIEW

SITZMÖBEL | SEATING FURNITURE

Vierfußstühle
Stahlrohrgestell

four legged chairs
steel tube frame



arketto
44



aticon
32



atlanta 55
72



atlanta 450
66



atlanta 456
62



garcia
38



listo
78



logochair
50

Freischwinger
Stahlrohrgestell

cantilever chairs
steel tube frame



atlanta 66 | 67
74



logochair swing
54

INDEX

Kufenstühle
Stahlgestell

skid-base chairs
steel frame



Eless
20



Karlsson
28

Holzstühle

wooden chairs



bonnie & clyde
82



elena
108



Kollektion.58
144



Krischanitz
Kollektion bentwood
150



Krischanitz
Kollektion bentwood
150



li-lith
126



PAN
94



PAN
98



PAN
96



rondo
114



rondo
116



tendo
136

Barhocker
Stahlrohrgestell

barstools
steel tube frame



aticon
34



Eless
24

INDEX



garcia
40



logochair
56



Stresemann
168

Barhocker
Holzgestell

barstools
wooden frame



clyde
86



elena
110



li-lith
128



PAN
100



Wiener Fauteuil
172

Bänke

benches



clyde
88



core
154



li-lith
130



Limes
254



Limes
256



logochair
58



PAN
102



rondo
120

INDEX

Loungemöbel

lounge furniture



Kollektion.58
142



Kollektion.58
142



Krischanitz
Kollektion bentwood
151



Krischanitz
Kollektion bentwood
151



rondo
118



rondo
122



Stresemann
166



Stresemann
166



Stresemann
166



Stresemann
166



Stresemann
166



Stresemann
166



Stresemann
166



ultimo
158



Wiener Fauteuil
172

INDEX

TISCHE | TABLES

Klapptische

folding tables



delta 104
188



delta 105
184



delta 110
178



delta 158
192



delta 181
190



system 24
198



system 24
206



system 24
208

Vierfüßliche
Stahlrohrgestell

four-legged tables
steel tube frame



206
212



207
214



logotable 306
218



logotable 307
220



tabula light 2010
224



tabula light 2040
226

Vierfüßliche
Holzgestell

four-legged tables
wooden frame



410
236



411
238



clyde
90

INDEX



Kollektion.58
144



Limes
258



PAN
104



tabula light 2000
228



tabula light 2020
230



tabula light 2030
232

Stehtische
Säulentische
Bistrotische

stand-up tables
column tables
bistro tables



2960 | 2961
248



2970 | 2971
250



412
240



stand up
244



Limes
260



Wiener Fauteuil
172

Beistelltische

side tables



Kollektion.58
142



logochair
58



PAN
98



Stresemann
166



ultimo
158

Hiller

WWW.HILLER-MOEBEL.DE

SCHNEEWEISS AG
interior

Ihr Fachhandelspartner:

weber büro- & objekteinrichtung GmbH

Dieselstr. 11a

86368 Gersthofen

T. 0821.262352-1

F. 0821.262352-2

E. info@weber-einrichtungen.de

www.weber-einrichtungen.de



weber

büro- & objekteinrichtung



PROJEKT. NEUES BÜRO